

Ceramic&Exsev bearing series

More and more bearings are being used in extreme special environments, such as in a vacuum, or in a clean, corrosive, or heated place. In some cases bearings are required to be insulated or antimagnetic.

Applications of bearings in such environments are increasing in the field of state-of-the-art technology, e.g. vacuum equipment, aerospace equipment and semi-conductor production facilities. Bearings made of conventional materials and lubricants can hardly meet these new needs.

JTEKT has succeeded in developing a series of bearings for use in extreme special environments, having started from the study of the very basics of materials and testing of their performance under various severe conditions.

JTEKT has standardized the following bearings as the "Koyo **EXSEV** bearing series".

- Exsev bearings for use in a clean environment
Designed for use in a vacuum.
The friction surface of the bearing interior is coated with solid lubricant (or soft metal). Bearings pre-lubricated with special grease are also available.
- Exsev bearings for use in a vacuum environment
Produce insignificant contamination, provided with rolling elements and a cage made of self-lubricating materials. Optimal for use in environments which need to be clean.
- Ceramic bearings
Ceramic rings and rolling elements (silicon nitride Si_3N_4) ensure excellent performance in various extreme special environments.
- For details, refer to JTEKT separate catalog "Ceramic bearings and **EXSEV** bearings for extreme special environments" (CAT. NO. B2004E).



Exsev bearings for use in a vacuum environment



Bore diameter 4 – 40 mm

Exsev bearings for use in a clean environment

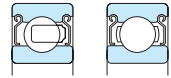

Bore diameter 4 – 40 mm

Ceramic bearings

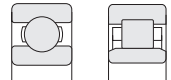

Bore diameter 4 – 120 mm

Linear ball bearings for vacuum

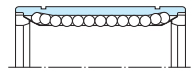

Ball complement bore diameter 3 – 40 mm

The chart below summarizes the EXSEV bearing series and the conditions in which each operates successfully.

Materials and lubricants which are resistant to certain special conditions are listed in Tables 1 and 2.

Major Koyo EXSEV bearing series made of these materials and lubricants are listed in Table 3.

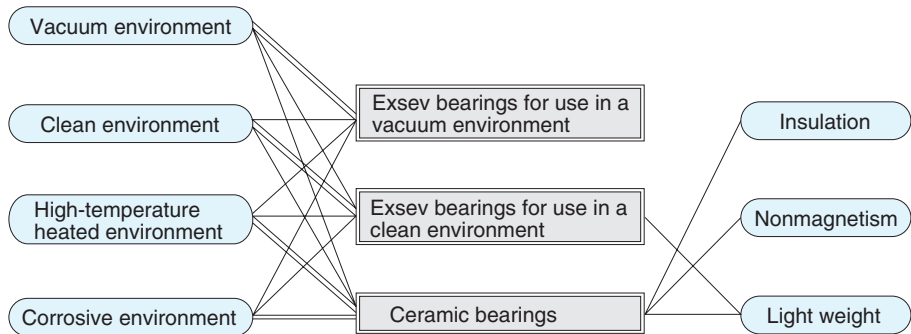

Lubricant	Operating temperature range °C	Vacuum resistance (room temperature) Pa	Steam pressure at high temperature Pa	Remarks	
Vacuum grease	- 30 to + 200	Atmospheric pressure (10 ⁵) to 10 ⁻⁵	-	Not to be used when grease affects operating environment.	
Solid lubricant	Polytetrafluoroethylene resin (PTFE)	- 100 to + 200	Atmospheric pressure to 10 ⁻⁵	Highly resistant to chemicals and highly insulating. Suitable when the environment repeats alternation between the atmosphere and a vacuum.	
	Molybdenum disulfide (MoS ₂)	- 100 to + 300	Atmospheric pressure to 10 ⁻⁵	Friction torque is low even in a vacuum. Not suitable for use in air at high temperature.	
	Lead ¹⁾ (Pb)	- 200 to + 300	10 ⁻³ to 10 ⁻¹⁰	10 ⁻⁶ (300°C)	Low friction torque. Not suitable for use in air.
	Silver ¹⁾ (Ag)	- 200 to + 600	10 ⁻³ to 10 ⁻¹⁰	10 ⁻⁵ (550°C)	Not suitable for use in air or in corrosive gas.

[Note] 1) Rolling elements or bearing rings are coated using the special ion plating method JTEKT developed.
 [Remark] The lubricants in the table above are usually applied to bearings for use in a vacuum. The most suitable one should be selected in consideration of the vacuum condition, temperature, and whether reactive gas or inert gas exists.











○ Good △ Fair × No good

Table 1 EXSEV bearing materials

Bearing material	Component				Operating temperature range °C	Vacuum resistance (room temperature) Pa	Density g/cm ³	Young's ¹⁾ modulus GPa	Coefficient ²⁾ of linear thermal expansion ×10 ⁻⁶ /°C	Self-lubrication	Insulation	Nonmagnetism	Corrosion resistance										Used to produce :					
	Bearing ring	Rolling element	Cage	Shield									Water	Sea water	Alkaliescent liquid	Weak acid liquid	Strong alkali liquid	Strong acid liquid			Molten metal		Hydrogen fluoride	Vacuum bearings	Ceramic bearings	Clean bearings		
Martensitic stainless steel	<input type="checkbox"/>	<input type="checkbox"/>			- 250 to + 400	Atmospheric pressure (10 ⁵) to 10 ⁻⁸	7.7	208	10.5	×	×	×	△	×	○	×	×	×	×	×	×	×					×	×
Precipitation hardening stainless steel	<input type="checkbox"/>	<input type="checkbox"/>			- 250 to + 400	Atmospheric pressure to 10 ⁻⁸	7.8	196	11.0	×	×	×	○	△	○	○	○	×	×	×	×	×	×	×	×	<input type="checkbox"/>	<input type="checkbox"/>	<input type="checkbox"/>
High speed tool steel	<input type="checkbox"/>	<input type="checkbox"/>			- 250 to + 550	Atmospheric pressure to 10 ⁻⁸	8.5	207	12.0	×	×	×	△	×	○	×	×	×	×	×	×	×	×	×	×	<input type="checkbox"/>	<input type="checkbox"/>	
Ceramics (Si ₃ N ₄)	<input type="checkbox"/>	<input type="checkbox"/>			- 270 to + 800	Atmospheric pressure to 10 ⁻⁸	3.2	320	3.2	×	○	○	○	○	○	○	△	○	○	○	○	×	×	×	×	<input type="checkbox"/>	<input type="checkbox"/>	
Graphite (GF)			<input type="checkbox"/>		+ 500 max.	-	2.15	-	5.5	○	×	○	○	○	○	○	○	○	○	○	○	○	○	○	○	<input type="checkbox"/>		
Reinforced fluorocarbon resin (FA)			<input type="checkbox"/>		- 100 to + 200	Atmospheric pressure to 10 ⁻⁶	1.9	-	-	○	○	○	○	○	○	○	○	○	○	○	×	×	○		<input type="checkbox"/>	<input type="checkbox"/>		
Reinforced fluorocarbon resin (PT)			<input type="checkbox"/>		- 100 to + 200	Atmospheric pressure to 10 ⁻⁴	2.15	-	-	○	○	○	○	○	○	○	○	○	○	×	×	○		<input type="checkbox"/>	<input type="checkbox"/>			
Reinforced PEEK resin (PN)			<input type="checkbox"/>		- 100 to + 300	Atmospheric pressure to 10 ⁻⁶	1.54	-	-	○	○	○	○	○	○	○	○	○	×	×	○		<input type="checkbox"/>	<input type="checkbox"/>				
Austenitic stainless steel			<input type="checkbox"/>	<input type="checkbox"/>	- 200 to + 300	Atmospheric pressure to 10 ⁻⁸	8.0	193	16.3	×	×	○	○	○	△	×	×	×	×	×	×	×	×	×	×	<input type="checkbox"/>	<input type="checkbox"/>	<input type="checkbox"/>
(Ref.) High carbon chromium bearing steel	<input type="checkbox"/>	<input type="checkbox"/>			- 200 to + 120	Atmospheric pressure to 10 ⁻⁸	7.8	208	12.5	×	×	×	×	×	×	×	×	×	×	×	×	×	×	×				

[Notes] 1) A larger Young's modulus indicates higher rigidity.
 2) A smaller coefficient of linear thermal expansion indicates a greater dimensional stability under heating.

Table 3 Koyo EXSEV bearing series models and types

		Exsev bearings for use in a vacuum environment				Exsev bearings for use in a clean environment			Ceramic bearings ⁴⁾														
Characteristics(selective points)	Vacuum resistance ¹⁾	Repeated alternation between atmospheric pressure and medium vacuum environments		Repeated alternation between atmospheric pressure and high vacuum environments		From high vacuum to ultra-high vacuum			Repeated alternation between atmospheric pressure and medium vacuum environments			atmospheric pressure											
	Operating temperature range, °C	- 30 to + 200		- 100 to + 300		- 100 to + 350		- 200 to + 350		- 30 to + 200			- 100 to + 200		- 30 to + 120		+ 500 max.						
	Cleanness	(class 100 ⁵⁾)				-			-			class 10 ⁵⁾											
	Corrosion resistance ²⁾	○		○		○		-		○			◎		-		-						
	Running friction torque	-		Low torque		Low torque		-		Extremely low torque			-										
	Others	-		-		-		Unstable for use with oxygen or corrosive gas		Longer life than clean pro bearing			-		-		Corrosion resistant		nonmagnetism	Insulation	High temperature		
Bearing types		DL bearing		MO bearing		WS bearing		MG bearing		Clean pro PRZ bearing			Clean pro bearing		High temperature clean pro bearing		Hybrid ceramic bearing		Hybrid ceramic bearing		Hybrid ceramic bearing		Hybrid ceramic bearing
																							
		SV...ST		SE...STMSA7		SE...STWS		SE...STMG3		SE...STPRZ			SE...STPR		SE...STPRB		3NC...MD4FA		3NC...YH4FA		3NC...FG		3NC...HT4GF
Materials	Inner ring and outer ring	Martensitic stainless steel							Martensitic stainless steel			Precipitation hardening stainless steel		Non-magnetic stainless steel		High carbon chrome bearing steel		High speed tool steel					
	Rolling elements (balls or rollers)								Martensitic stainless steel			Ceramics											
	Cage	Austenitic stainless steel		Tungsten disulfide (WS)		Austenitic stainless steel					Austenitic stainless steel			Fluorocarbon resin (FA)		Polyamide resin		Graphite (GF)					
Lubricant	Vacuum grease		Cage coated with molybdenum disulfide(MoS ₂)		Self-lubrication ⁶⁾		Balls coated with ³⁾ silver(Ag)					Fluorocarbon-base polymeric coating			Self-lubrication ⁶⁾		Vacuum grease		Self-lubrication ⁶⁾				
Applications	Vacuum pump, general vacuum equipment		P-CVD equipment for manufacture of semiconductors and electronic parts, sputtering equipment				Electron beam epitaxial equipment					Semiconductor manufacturing			Food or chemical manufacturing equipment		Vacuum equipment		Motors		Heat roll heat treatment furnaces		

[Notes] 1) Vacuum (pressure) is generally graded as follows :
 Low vacuum.....10⁵ - 10²Pa
 Medium vacuum.....10² - 10⁻¹Pa
 High vacuum.....10⁻¹ - 10⁻⁵Pa
 Ultra-high vacuum.....10⁻⁵Pa or less
 Extremely high vacuum.....10⁻⁸Pa or less (Atmospheric pressure ≈ 10⁵Pa)
 2) The corrosion resistance column shows general evaluations.
 Marks "◎" and "○", respectively, denote "excellent", "good", and "fair".
 Refer to Table 1 for the corrosive materials concerned.

3) These soft metals are applied by the special ion plating method JTEKT developed, so that they feature excellent bonding strength, extending the service life of bearings.
 4) When higher corrosion resistance, nonmagnetism and heat resistance are required, Full Ceramic Bearings should be used. Please consult with JTEKT for details.
 Ceramics can also be used to produce many types of bearings, such as angular contact ball bearings and cylindrical roller bearings.

5) These evaluations indicate the cleanness around the bearing, or in the equipment interior. Cleanness is largely dependent on the amount of dirt produced by operation of the bearing. The suffixed numbers refer to amounts of dirt, and the smaller the number is, the less dirt produced by the bearing.
 [Ex.] Class 10.....there are less than 10 particles 0.5 μm or larger in diameter in a 1-cubic-foot space.(as specified in USA standards FED-STD-209D.)

6) Because the cage is made from self-lubricating material.

■ Life of EXSEV Bearings

EXSEV bearings, lubricated with a solid lubricant, are usually used under relatively light load conditions, such as 10% of their static load ratings or less. These bearings can maintain stable performance as long as the solid lubricant is maintained. Once the lubricant wears out, metallic contact occurs, which increases rotational friction torque and shortens service life.

Service life depends on use conditions. At present, it is not possible to predict their service life under varied use conditions. However, based on a variety of experiments and tests, JTEKT has established an experimental formulae to predict the lives of bearings. The formulae is described in the following subsections for reference only.

(1) Life of MG bearings consisting of silver-coated balls

The life of MG bearings (JTEKT serial number, SE...STMG3) can be predicted according to the following formula;

$$L_{vh} = b_1 \cdot b_2 \cdot b_3 (C_v/P)^q \times 16\,667/n \dots\dots\dots (1)$$

- where,
 L_{vh} : 90% reliable life, h
 C_v : Basic dynamic load rating of vacuum-resistant ball bearings (1/13 of basic dynamic load rating of steel bearings of equal size), N
 P : Dynamic equivalent load, N
 q : Index, $q = 1$
 n : Rotational speed, min^{-1} , limited to $10 \leq n \leq 10\,000$
 b_1 : Rotational speed-dependant coefficient
 $b_1 = 1.5 \times 10^{-3}n + 1$
 b_2 : Material coefficient
 $b_2 = 1$ (for bearings ion-plated with silver by the special ion-plating process)
 b_3 : Coefficient for atmospheric pressure and temperature
 $b_3 = 1$ (for 10^{-3} Pa and room temperature)

(2) For bearings coated with PTFE or special polymeric fluoride

For those bearings coated with PTFE (MP7) or those coated with the special polymeric fluoride (PR), the following formula gives their mean life for reference only. (See Fig. 3.8.)

$$L_{av} = b_2 \cdot (C_e/P)^d \times 0.016667/n \dots\dots\dots (2)$$

- where,
 L_{av} : Average life, h
 b_2 : Lubrication coefficient
 6 for bearings coated with PTFE
 42 for bearings coated with special polymeric fluoride
 C_e : 0.85 times the basic dynamic load rating of steel bearings of equal size, N
 P : Dynamic equivalent load, N
 d : Coefficient, $d = 3$
 n : Rotational speed, min^{-1}

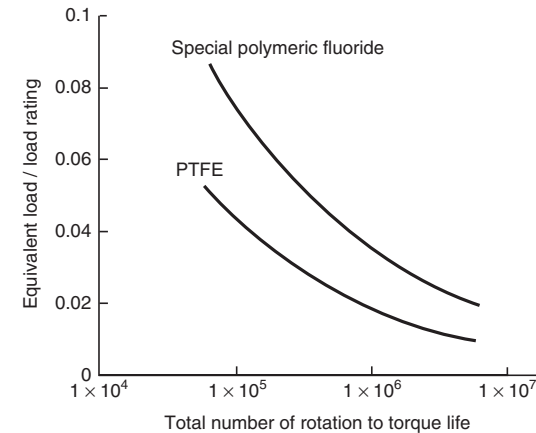

Fig. 1 Mean life of Coated Bearings

(3) Ceramic bearing service life

Ceramic bearings are used for a variety of pur-poses, and their specifications differ case by case. Therefore, there is no common system for estimating their service lives.

The estimation of full ceramic bearing service life is especially difficult at present for theoretical reasons, and requires further study.

JTEKT estimates the full ceramic bearing service life on a case by case basis according to the customer request, based on experience and experimental data.

For hybrid ceramic bearings, in many cases the conventional equation (2) below based on rolling contact fatigue is used to estimate service life, where grease or oil can be used for lubrication and, at the same time, bearings are required to be insulating and antimagnetic, or to be highly rigid and have excellent high-speed performance.

This equation is called the corrected rated life estimation equation. (refer to p. A 26.)

$$L_{na} = a_1 a_2 a_3 L_{10} = a_1 a_2 a_3 (C/P)^p \dots\dots\dots (3)$$

- In an environment where a lubricating film is formed properly, the bearing characteristic coefficient a_2 is expected to be equivalent to or larger than that of conventional steel bearings. However, given current conditions, coefficient a_2 is counted as : $a_2 = 1$. Basic dynamic load rating C is treated as being equivalent to that of steel bearings of the same type and size.
- When a satisfactory oil film is formed, the operating condition coefficient a_3 is counted as : $a_3 > 1$.

EXSEV bearing series
for use in a vacuum environment

d 4 ~ 17 mm

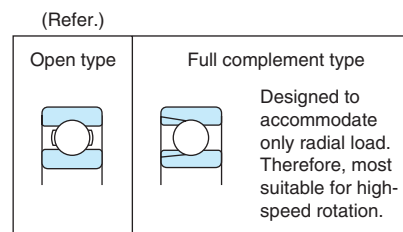
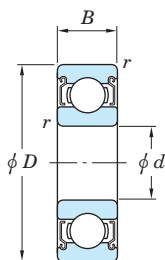

Boundary dimensions (mm)				Bearing No.			(Refer.) Basic bearing			
d	D	B	$r^{1)}$ min.	Atmospheric pressure to 10^{-5} Pa			10^{-3} to 10^{-10} Pa Ag ion-plating (balls)	Basic load ratings (kN)		
				With vacuum grease filled	MoS ₂ coating (cage)			Bearing No.	C_r	C_{0r}
4	10	4	0.1(0.15)	SVWML 4010 ZZST	SEWML 4010 ZZSTMSA7		—	WML4010	0.65	0.23
	12	4	0.2	SV 604 ZZST	SE 604 ZZSTMSA7		SE 604 ZZSTMG3	604	0.97	0.36
	13	5	0.2	SV 624 ZZST	SE 624 ZZSTMSA7		SE 624 ZZSTMG3	624	1.30	0.49
5	14	5	0.2	SV 605 ZZST	SE 605 ZZSTMSA7		SE 605 ZZSTMG3	605	1.30	0.49
	16	5	0.3	SV 625 ZZST	SE 625 ZZSTMSA7		SE 625 ZZSTMG3	625	1.75	0.67
6	10	3	0.08(0.1)	SVWML 6010 ZZST	SEWML 6010 ZZSTMSA7		—	WML6010	0.36	0.16
	12	4	0.1(0.15)	SVWML 6012 ZZST	SEWML 6012 ZZSTMSA7		—	WML6012	0.71	0.29
	13	5	0.15	SV 686 ZZST	SE 686 ZZSTMSA7		SE 686 ZZSTMG3	686	1.10	0.44
	17	6	0.3	SV 606 ZZST	SE 606 ZZSTMSA7		SE 606 ZZSTMG3	606	1.95	0.74
	19	6	0.3	SV 626 ZZST	SE 626 ZZSTMSA7		SE 626 ZZSTMG3	626	2.60	1.05
7	19	6	0.3	SV 607 ZZST	SE 607 ZZSTMSA7		SE 607 ZZSTMG3	607	2.60	1.05
	22	7	0.3	SV 627 ZZST	SE 627 ZZSTMSA7		SE 627 ZZSTMG3	627	3.30	1.35
8	22	7	0.3	SV 608 ZZST	SE 608 ZZSTMSA7		SE 608 ZZSTMG3	608	3.30	1.35
	24	8	0.3	SV 628 ZZST	SE 628 ZZSTMSA7		SE 628 ZZSTMG3	628	3.35	1.40
9	24	7	0.3	SV 609 ZZST	SE 609 ZZSTMSA7		SE 609 ZZSTMG3	609	3.35	1.40
	26	8	0.6	SV 629 ZZST	SE 629 ZZSTMSA7		SE 629 ZZSTMG3	629	4.55	1.95
10	26	8	0.3	SV 6000 ZZST	SE 6000 ZZSTMSA7		SE 6000 ZZSTMG3	6000	4.55	1.95
	30	9	0.6	SV 6200 ZZST	SE 6200 ZZSTMSA7		SE 6200 ZZSTMG3	6200	5.10	2.40
12	28	8	0.3	SV 6001 ZZST	SE 6001 ZZSTMSA7		SE 6001 ZZSTMG3	6001	5.10	2.40
	32	10	0.6	SV 6201 ZZST	SE 6201 ZZSTMSA7		SE 6201 ZZSTMG3	6201	6.80	3.05
15	32	9	0.3	SV 6002 ZZST	SE 6002 ZZSTMSA7		SE 6002 ZZSTMG3	6002	5.60	2.85
	35	11	0.6	SV 6202 ZZST	SE 6202 ZZSTMSA7		SE 6202 ZZSTMG3	6202	7.65	3.75
17	35	10	0.3	SV 6003 ZZST	SE 6003 ZZSTMSA7		SE 6003 ZZSTMG3	6003	6.00	3.25
	40	12	0.6	SV 6203 ZZST	SE 6203 ZZSTMSA7		SE 6203 ZZSTMG3	6203	9.55	4.80

[Note] 1) The value in () shows the minimum chamfer dimension of open type bearings. If there is no indication, the value is the same as that of the shielded type (zz).

EXSEV bearing series
for use in a vacuum environment

d 20 ~ 40 mm

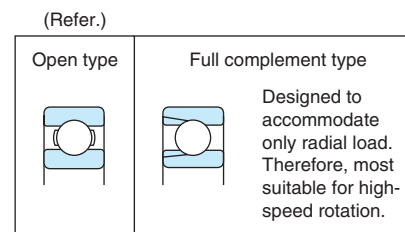
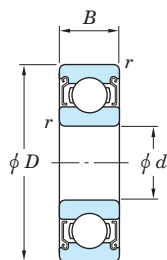

Boundary dimensions (mm)				Bearing No.			(Refer.) Basic bearing		
d	D	B	$r^{1)}$ min.	Atmospheric pressure to 10^{-5} Pa		10^{-3} to 10^{-10} Pa Ag ion-plating (balls)	Basic load ratings (kN)		
				With vacuum grease filled	MoS ₂ coating (cage)		Bearing No.	C_r	C_{0r}
20	42	12	0.6	SV 6004 ZZST	SE 6004 ZZSTMSA7	SE 6004 ZZSTMG3	6004	9.40	5.05
	47	14	1	SV 6204 ZZST	SE 6204 ZZSTMSA7		SE 6204 ZZSTMG3	6204	12.8
25	47	12	0.6	SV 6005 ZZST	SE 6005 ZZSTMSA7	SE 6005 ZZSTMG3	6005	10.1	5.85
	52	15	1	SV 6205 ZZST	SE 6205 ZZSTMSA7		SE 6205 ZZSTMG3	6205	14.0
30	55	13	1	SV 6006 ZZST	SE 6006 ZZSTMSA7	SE 6006 ZZSTMG3	6006	13.2	8.25
	62	16	1	SV 6206 ZZST	SE 6206 ZZSTMSA7		SE 6206 ZZSTMG3	6206	19.5
35	62	14	1	SV 6007 ZZST	SE 6007 ZZSTMSA7	SE 6007 ZZSTMG3	6007	15.9	10.3
	72	17	1.1	SV 6207 ZZST	SE 6207 ZZSTMSA7		SE 6207 ZZSTMG3	6207	25.7
40	68	15	1	SV 6008 ZZST	SE 6008 ZZSTMSA7	SE 6008 ZZSTMG3	6008	16.7	11.5
	80	18	1.1	SV 6208 ZZST	SE 6208 ZZSTMSA7		SE 6208 ZZSTMG3	6208	29.1

[Note] 1) The value in () shows the minimum chamfer dimension of open type bearings. If there is no indication, the value is the same as that of the shielded type (zz).

EXSEV bearing series
for use in a clean environment

d 4 ~ (25) mm

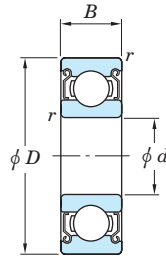

d	Boundary dimensions (mm)			Bearing No.			
	D	B	r min.	-30°C to 200°C Clean Class10	-100°C to 200°C Clean Class10		200°C to 260°C Clean Class10
4	12	4	0.2	—	SE 604 ZZSTPR		SE 604 ZZSTPRB
	13	5	0.2	—	SE 624 ZZSTPR		SE 624 ZZSTPRB
5	14	5	0.2	SE 605 ZZSTPRZ	SE 605 ZZSTPR		SE 605 ZZSTPRB
	16	5	0.3	SE 625 ZZSTPRZ	SE 625 ZZSTPR		SE 625 ZZSTPRB
6	12	4	—	SEWML6012-1 ZZSTPRZ	SEWML6012-1 ZZSTPR		SEWML6012-1 ZZSTPRB
	13	5	—	SEW686 ZZSTPRZ	SEW686 ZZSTPR		SEW686 ZZSTPRB
	17	6	0.3	SE 606 ZZSTPRZ	SE 606 ZZSTPR		SE 606 ZZSTPRB
	19	6	0.3	SE 626 ZZSTPRZ	SE 626 ZZSTPR		SE 626 ZZSTPRB
7	19	6	0.3	SE 607 ZZSTPRZ	SE 607 ZZSTPR		SE 607 ZZSTPRB
	22	7	0.3	SE 627 ZZSTPRZ	SE 627 ZZSTPR		SE 627 ZZSTPRB
8	22	7	0.3	SE 608 ZZSTPRZ	SE 608 ZZSTPR		SE 608 ZZSTPRB
	24	8	0.3	SE 628 ZZSTPRZ	SE 628 ZZSTPR		SE 628 ZZSTPRB
9	24	7	0.3	SE 609 ZZSTPRZ	SE 609 ZZSTPR		SE 609 ZZSTPRB
	26	8	0.6	SE 629 ZZSTPRZ	SE 629 ZZSTPR		SE 629 ZZSTPRB
10	26	8	0.3	SE 6000 ZZSTPRZ	SE 6000 ZZSTPR		SE 6000 ZZSTPRB
	30	9	0.6	SE 6200 ZZSTPRZ	SE 6200 ZZSTPR		SE 6200 ZZSTPRB
12	28	8	0.3	SE 6001 ZZSTPRZ	SE 6001 ZZSTPR		SE 6001 ZZSTPRB
	32	10	0.6	SE 6201 ZZSTPRZ	SE 6201 ZZSTPR		SE 6201 ZZSTPRB
15	32	9	0.3	SE 6002 ZZSTPRZ	SE 6002 ZZSTPR		SE 6002 ZZSTPRB
	35	11	0.6	SE 6202 ZZSTPRZ	SE 6202 ZZSTPR		SE 6202 ZZSTPRB
17	35	10	0.3	SE 6003 ZZSTPRZ	SE 6003 ZZSTPR		SE 6003 ZZSTPRB
	40	12	0.6	SE 6203 ZZSTPRZ	SE 6203 ZZSTPR		SE 6203 ZZSTPRB
20	42	12	0.6	SE 6004 ZZSTPRZ	SE 6004 ZZSTPR		SE 6004 ZZSTPRB
	47	14	1	SE 6204 ZZSTPRZ	SE 6204 ZZSTPR		SE 6204 ZZSTPRB
25	47	12	0.6	SE 6005 ZZSTPRZ	SE 6005 ZZSTPR		SE 6005 ZZSTPRB

EXSEV bearing series
for use in a clean environment

d (25) ~ 40 mm

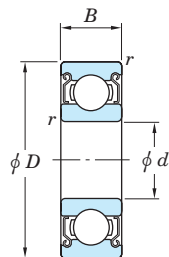

Boundary dimensions (mm)				Bearing No.			
d	D	B	r min.	-30°C to 200°C Clean Class10	-100°C to 200°C Clean Class10		200°C to 260°C Clean Class10
25	52	15	1	SE 6205 ZZSTPRZ	SE 6205 ZZSTPR		SE 6205 ZZSTPRB
30	55	13	1	SE 6006 ZZSTPRZ	SE 6006 ZZSTPR		SE 6006 ZZSTPRB
	62	16	1	SE 6206 ZZSTPRZ	SE 6206 ZZSTPR		SE 6206 ZZSTPRB
35	62	14	1	SE 6007 ZZSTPRZ	SE 6007 ZZSTPR		SE 6007 ZZSTPRB
	72	17	1.1	SE 6207 ZZSTPRZ	SE 6207 ZZSTPR		SE 6207 ZZSTPRB
40	68	15	1	SE 6008 ZZSTPRZ	SE 6008 ZZSTPR		SE 6008 ZZSTPRB
	80	18	1.1	SE 6208 ZZSTPRZ	SE 6208 ZZSTPR		SE 6208 ZZSTPRB

d 4 ~ 25 mm

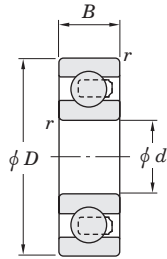

Boundary dimensions (mm)				Bearing No.					Full ceramic type	
d	D	B	r min.	Hybrid ceramic type					High temperature (up to 800°C)	For corrosion resistance/ Non magnetism/Insulation
				High temperature (up to 500°C)	For corrosion resistance	Non magnetism	Insulation			
4	12	4	0.2	—	3NC604MD4	3NC604YH4	3NC604ST4		—	NC604
	13	5	0.2	—	3NC624MD4	3NC624YH4	3NC624ST4		—	NC624
5	14	5	0.2	—	3NC605MD4	3NC605YH4	3NC605ST4		—	NC605
	16	5	0.3	—	3NC625MD4	3NC625YH4	3NC625ST4		—	NC625
6	17	6	0.3	3NC606HT4 GF	3NC606MD4	3NC606YH4	3NC606ST4		NC706V	NC606
	19	6	0.3	3NC626HT4 GF	3NC626MD4	3NC626YH4	3NC626ST4		NC726V	NC626
7	19	6	0.3	3NC607HT4 GF	3NC607MD4	3NC607YH4	3NC607ST4		NC707V	NC607
	22	7	0.3	3NC627HT4 GF	3NC627MD4	3NC627YH4	3NC627ST4		NC727V	NC627
8	22	7	0.3	3NC608HT4 GF	3NC608MD4	3NC608YH4	3NC608ST4		NC708V	NC608
	24	8	0.3	3NC628HT4 GF	3NC628MD4	3NC628YH4	3NC628ST4		NC728V	NC628
9	24	7	0.3	3NC609HT4 GF	3NC609MD4	3NC609YH4	3NC609ST4		NC709V	NC609
	26	8	0.6	3NC629HT4 GF	3NC629MD4	3NC629YH4	3NC629ST4		NC729V	NC629
10	26	8	0.3	3NC6000HT4 GF	3NC6000MD4	3NC6000YH4	3NC6000ST4		NC7000V	NC6000
	30	9	0.6	3NC6200HT4 GF	3NC6200MD4	3NC6200YH4	3NC6200ST4		NC7200V	NC6200
12	28	8	0.3	3NC6001HT4 GF	3NC6001MD4	3NC6001YH4	3NC6001ST4		NC7001V	NC6001
	32	10	0.6	3NC6201HT4 GF	3NC6201MD4	3NC6201YH4	3NC6201ST4		NC7201V	NC6201
15	32	9	0.3	3NC6002HT4 GF	3NC6002MD4	3NC6002YH4	3NC6002ST4		NC7002V	NC6002
	35	11	0.6	3NC6202HT4 GF	3NC6202MD4	3NC6202YH4	3NC6202ST4		NC7202V	NC6202
17	35	10	0.3	3NC6003HT4 GF	3NC6003MD4	3NC6003YH4	3NC6003ST4		NC7003V	NC6003
	40	12	0.6	3NC6203HT4 GF	3NC6203MD4	3NC6203YH4	3NC6203ST4		NC7203V	NC6203
20	42	12	0.6	3NC6004HT4 GF	3NC6004MD4	3NC6004YH4	3NC6004ST4		NC7004V	NC6004
	47	14	1	3NC6204HT4 GF	3NC6204MD4	3NC6204YH4	3NC6204ST4		NC7204V	NC6204
25	47	12	0.6	3NC6005HT4 GF	3NC6005MD4	3NC6005YH4	3NC6005ST4		NC7005V	NC6005
	52	15	1	3NC6205HT4 GF	3NC6205MD4	3NC6205YH4	3NC6205ST4		NC7205V	NC6205

d 30 ~ 40 mm

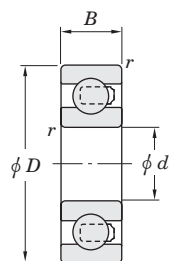

Boundary dimensions (mm)				Bearing No.						
d	D	B	r min.	Hybrid ceramic type				Full ceramic type		
				High temperature (up to 500°C)	For corrosion resistance	Non magnetism	Insulation	High temperature (up to 800°C)	For corrosion resistance/ Non magnetism/Insulation	
30	55	13	1	3NC6006HT4 GF	3NC6006MD4	3NC6006YH4	3NC6006ST4		NC7006V	NC6006
	62	16	1	3NC6206HT4 GF	3NC6206MD4	3NC6206YH4	3NC6206ST4		NC7206V	NC6206
35	62	14	1	3NC6007HT4 GF	3NC6007MD4	3NC6007YH4	3NC6007ST4		NC7007V	NC6007
	72	17	1.1	3NC6207HT4 GF	3NC6207MD4	3NC6207YH4	3NC6207ST4		NC7207V	NC6207
40	68	15	1	3NC6008HT4 GF	3NC6008MD4	3NC6008YH4	3NC6008ST4		NC7008V	NC6008
	80	18	1.1	3NC6208HT4 GF	3NC6208MD4	3NC6208YH4	3NC6208ST4		NC7208V	NC6208

Refer. Hybrid ceramic bearings (for high speed applications)

d 15 ~ (75) mm

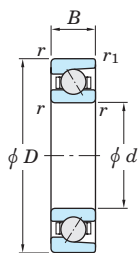

70,72 series

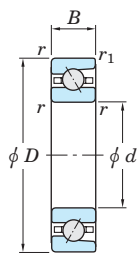

HAR 0,9 series

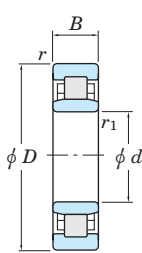

NU 10 series

* This type of bearing is mainly used in high speed rotating parts such as machine tool spindles. Since rolling elements are made of ceramics, this type of bearing is shown here, even though not designed as EXSEV bearing series. (Bearing rings are made of high carbon chromium bearing steel)

Boundary dimensions (mm)					Bearing No.			(Refer.) Basic bearing								
d	D	B	r min.	r_1 min.	Angular contact ball bearings		Cylindrical roller bearings NU 10 series	Bearing No. 70,72	Basic load ratings (kN)		Bearing No. HAR 0,9	Basic load ratings (kN)		Bearing No. NU 10	Basic load ratings (kN)	
					70,72 series	HAR 0,9 series			C_r	C_{0r}		C_r	C_{0r}		C_r	C_{0r}
15	32	9	0.3	0.15	3NC 7002 FT	—	—	7002	6.10	3.45	—	—	—	—	—	—
	35	11	0.6	0.3	3NC 7202 FT	—	—	7202	8.10	4.25	—	—	—	—	—	—
20	42	12	0.6	0.3	3NC 7004 FT	—	—	7004	10.3	6.10	—	—	—	—	—	—
	47	14	1	0.6	3NC 7204 FT	—	—	7204	14.5	8.40	—	—	—	—	—	—
25	47	12	0.6	0.3	3NC 7005 FT	—	—	7005	11.3	7.40	—	—	—	—	—	—
	52	15	1	0.6	3NC 7205 FT	—	—	7205	15.3	9.50	—	—	—	—	—	—
30	55	13	1	0.6	3NC 7006 FT	3NC HAR006C FT	—	7006	14.5	10.1	HAR006C	8.7	4.85	—	—	—
	62	16	1	0.6	3NC 7206 FT	—	—	7206	21.3	13.7	—	—	—	—	—	—
35	62	14	1	0.6	3NC 7007 FT	3NC HAR007C FT	—	7007	17.5	12.6	HAR007C	9.25	5.55	—	—	—
	72	17	1.1	0.6	3NC 7207 FT	—	—	7207	28.1	18.6	—	—	—	—	—	—
40	68	15	1	0.6	3NC 7008 FT	3NC HAR008C FT	—	7008	18.7	14.6	HAR008C	9.70	6.20	—	—	—
	80	18	1.1	0.6	3NC 7208 FT	—	—	7208	33.6	23.3	—	—	—	—	—	—
45	75	16	1	0.6	3NC 7009 FT	3NC HAR009C FT	—	7009	22.2	17.7	HAR009C	10.9	7.1	—	—	—
50	72	12	0.6	0.3	—	3NC HAR910C FT	—	—	—	—	HAR910C	9.10	6.30	—	—	—
	80	16	1	0.6	3NC 7010 FT	3NC HAR010C FT	3NC NU1010 FY	7010	23.6	20.1	HAR010C	11.4	7.85	NU1010	33.6	36.8
55	80	13	1	0.6	—	3NC HAR911C FT	—	—	—	—	HAR911C	10.1	7.65	—	—	—
	90	18	1.1	0.6	3NC 7011 FT	3NC HAR011C FT	3NC NU1011 FY	7011	31.1	26.3	HAR011C	14.1	9.9	NU1011	37.4	43.8
60	85	13	1	0.6	—	3NC HAR912C FT	—	—	—	—	HAR912C	9.95	7.75	—	—	—
	95	18	1.1	0.6	3NC 7012 FT	3NC HAR012C FT	3NC NU1012 FY	7012	31.9	28.1	HAR012C	14.7	10.8	NU1012	42.1	50.0
65	90	13	1	0.6	—	3NC HAR913C FT	—	—	—	—	HAR913C	11.8	9.45	—	—	—
	100	18	1.1	0.6	3NC 7013 FT	3NC HAR013C FT	3NC NU1013 FY	7013	33.7	31.4	HAR013C	15.3	11.8	NU1013	43.3	52.9
70	100	16	1	0.6	—	3NC HAR914C FT	—	—	—	—	HAR914C	12.9	10.5	—	—	—
	110	20	1.1	0.6	3NC 7014 FT	3NC HAR014C FT	3NC NU1014 FY	7014	42.7	39.4	HAR014C	20.7	15.5	NU1014	57.9	70.4
75	105	16	1	0.6	—	3NC HAR915C FT	—	—	—	—	HAR915C	13.3	11.2	—	—	—

Refer. Hybrid ceramic bearings (for high speed applications)

d (75) ~ 120 mm

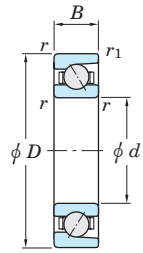

70,72 series

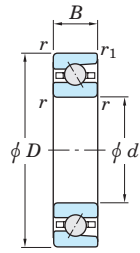

HAR 0,9 series

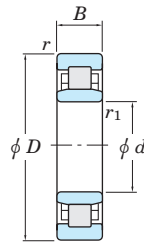

NU 10 series

* This type of bearing is mainly used in high speed rotating parts such as machine tool spindles. Since rolling elements are made of ceramics, this type of bearing is shown here, even though not designed as EXSEV bearing series.
(Bearing rings are made of high carbon chromium bearing steel)

Boundary dimensions (mm)					Bearing No.			(Refer.) Basic bearing								
d	D	B	r min.	r_1 min.	Angular contact ball bearings		Cylindrical roller bearings NU 10 series	Bearing No. 70,72	Basic load ratings (kN)		Bearing No. HAR 0,9	Basic load ratings (kN)		Bearing No. NU 10	Basic load ratings (kN)	
					70,72 series	HAR 0,9 series			C_r	C_{0r}		C_r	C_{0r}		C_r	C_{0r}
75	115	20	1.1	0.6	3NC 7015 FT	3NC HAR015C FT	3NC NU1015 FY	7015	43.6	41.7	HAR015C	21.1	16.2	NU1015	63.6	78.1
	125	22	1.1	0.6	—	3NC HAR016C FT	3NC NU1016 FY	—	—	—	HAR016C	24.7	19.2	NU1016	69.3	86.4
85	120	18	1.1	0.6	—	3NC HAR017C FT	—	—	—	—	HAR017C	25.1	20.1	—	—	—
	130	22	1.1	0.6	—	3NC HAR017C FT	3NC NU1017 FY	—	—	—	HAR017C	25.1	20.1	NU1017	71.4	91.2
90	125	18	1.1	0.6	—	3NC HAR018C FT	—	—	—	—	HAR018C	16.8	15.1	—	—	—
	140	24	1.5	1	—	3NC HAR018C FT	3NC NU1018 FY	—	—	—	HAR018C	32.8	26.1	NU1018	84.7	109
95	130	18	1.1	0.6	—	3NC HAR019C FT	—	—	—	—	HAR019C	17.3	16.0	—	—	—
	145	24	1.5	1	—	3NC HAR019C FT	3NC NU1019 FY	—	—	—	HAR019C	33.4	27.2	NU1019	87.2	115
100	140	20	1.1	0.6	—	3NC HAR020C FT	—	—	—	—	HAR020C	24.2	21.7	—	—	—
	150	24	1.5	1	—	3NC HAR020C FT	3NC NU1020 FY	—	—	—	HAR020C	34.0	28.4	NU1020	91.0	120
105	145	20	1.1	0.6	—	3NC HAR021C FT	—	—	—	—	HAR021C	24.9	23.1	—	—	—
	160	26	2	1	—	3NC HAR021C FT	—	—	—	—	HAR021C	38.6	32.5	—	—	—
110	150	20	1.1	0.6	—	3NC HAR022C FT	—	—	—	—	HAR022C	25.1	23.8	—	—	—
	170	28	2	1	—	3NC HAR022C FT	—	—	—	—	HAR022C	43.4	37.0	—	—	—
120	165	22	1.1	0.6	—	3NC HAR024C FT	—	—	—	—	HAR024C	29.4	28.4	—	—	—
	180	28	2	1	—	3NC HAR024C FT	—	—	—	—	HAR024C	44.9	39.9	—	—	—

EXSEV bearing series
Linear ball bearings for vacuum

d 3 ~ 60 mm



Shaft dia. (mm)	Boundary dimensions (mm)								Bearing No.			Basic load ratings (kN)		No. of ball rows			
	d	D	L	B	W	D_1	h	h_1	θ	Standard type	Clearance adjustable type	Open type	C	C_0	Standard type	Clearance adjustable type	Open type
3	7	10	—	—	—	—	—	—	—	SESDM 3	—	—	69	105	4	—	—
4	8	12	—	—	—	—	—	—	—	SESDM 4	—	—	88	127	4	—	—
5	10	15	10.2	1.1	9.6	—	—	—	—	SESDM 5	—	—	167	206	4	—	—
6	12	19	13.5	1.1	11.5	—	—	—	—	SESDM 6	—	—	206	265	4	—	—
8	15	17	11.5	1.1	14.3	—	—	—	—	SESDM 8S	—	—	176	216	4	—	—
	15	24	17.5	1.1	14.3	—	—	—	—	SESDM 8	—	—	274	392	4	—	—
10	19	29	22	1.3	18	—	—	—	—	SESDM10	—	—	372	549	4	—	—
12	21	30	23	1.3	20	1.5	8	80°	—	SESDM12	SESDM12 AJ	SESDM12 OP	510	784	4	4	3
13	23	32	23	1.3	22	1.5	9	80°	—	SESDM13	SESDM13 AJ	SESDM13 OP	510	784	4	4	3
16	28	37	26.5	1.6	27	1.5	11	80°	—	SESDM16	SESDM16 AJ	SESDM16 OP	774	1 180	4	4	3
20	32	42	30.5	1.6	30.5	1.5	11	60°	—	SESDM20	SESDM20 AJ	SESDM20 OP	882	1 370	5	5	4
25	40	59	41	1.85	38	2	12	50°	—	SESDM25	SESDM25 AJ	SESDM25 OP	980	1 570	6	6	5
30	45	64	44.5	1.85	43	2.5	15	50°	—	SESDM30	SESDM30 AJ	SESDM30 OP	1 570	2 740	6	6	5
35	52	70	49.5	2.1	49	2.5	17	50°	—	SESDM35	SESDM35 AJ	SESDM35 OP	1 670	3 140	6	6	5
40	60	80	60.5	2.1	57	3	20	50°	—	SESDM40	SESDM40 AJ	SESDM40 OP	2 160	4 020	6	6	5
50	80	100	74	2.6	76.5	3	25	50°	—	SESDM50	SESDM50 AJ	SESDM50 OP	3 820	7 940	6	6	5
60	90	110	85	3.15	86.5	3	30	50°	—	SESDM60	SESDM60 AJ	SESDM60 OP	4 700	10 000	6	6	5

K-series super thin section ball bearings

Koyo K-series super thin section ball bearings were developed to meet current engineering needs for thinner, lighter bearings. They are used extensively in automation and labor saving equipment, such as industrial robots.

These bearings are sorted into nine dimension series according to cross-sectional area.

Those of the same dimension series have an equivalent cross-sectional area irrespective of the bore diameter.

They are available in three types that differ in structure.

- **Deep groove type**
Carries radial load, axial load in both directions, and combined loads.
- **Angular contact type**
Has a 30° contact angle, and carries radial load and axial load in one direction. Two bearings are usually used together facing one another.
- **Four-point contact type**
Has a contact angle of 30° both to the right and to the left. Able to carry axial load in both directions. Also able to support moment and radial loads.



Dimension series code	Cross-sectional dimension $B = E$ (mm)	Bearing type code			Bore diameter (mm)
		C (Deep groove type)	A (Angular contact type)	X (Four-point contact type)	
T	4.762	KTC	KTA	KTX	25.4 to 38.1
A	6.35	KAC	KAA	KAX	50.8 to 304.8
B	7.938	KBC	KBA	KBX	50.8 to 508
C	9.525	KCC	KCA	KCX	101.6 to 762
D	12.7	KDC	KDA	KDX	
F	19.05	KFC	KFA	KFX	101.6 to 1016
G	25.4	KGC	KGA	KGX	
J	$B = 11.1$ $E = 9.525$	-	KJA...RD 	-	101.6 to 304.8
U	$B = 12.7$ $E = 9.525$	KUC...2RD 	-	KUX...2RD 	

Table 1 K-series super thin section ball bearings : tolerance

Bore diameter number	Single plane mean bore diameter deviation					Single plane mean outside diameter deviation					Single inner (outer) ring width deviation			Radial runout of assembled bearing ring, max.										Assembled bearing ring face runout with raceway, max.				Bore diameter number
	Δ_{dmp}					Δ_{Dmp}					Δ_{Bs}, Δ_{Cs}			Inner ring K_{ia}					Outer ring K_{ea}					Inner ring S_{ia}		Outer ring S_{ea}		
	classes K0, K1, K2		class K3	class K4	class K6	classes K0, K1, K2		class K3	class K4	class K6	classes K0, K1, K2	classes K3, K4	class K6	class K0	class K3	classes K1, K4	classes K2, K6	class K0	class K3	classes K1, K4	classes K2, K6	classes K1, K4	classes K0, K2, K3, K6	classes K1, K4	classes K0, K2, K3, K6			
	div. I	div. II				div. I	div. II							div. I	div. II													
010	0 -10	0 -5	0 -5	0 -4			0 -8	0 -5	0 -5				13	8	8										010			
015	0 -13	0 -8	0 -5	0 -5			0 -8	0 -5	0 -5				15	10											015			
020																									020			
025	0 -15	0 -10		0 -5									20	13	10	5	4								025			
030																									030			
035																									035			
040																									040			
042	0 -20	0 -13		0 -6									25		13										042			
045																									045			
047																									047			
050																									050			
055	0 -25	0 -15	0 -10	0 -8									30												055			
060																									060			
065																									065			
070																									070			
075																									075			
080	0 -30	0 -18		0 -10									41	30	20	10									080			
090																									090			
100																									100			
110	0 -36	0 -36	0 -20	0 -13									46	36	25	13	10								110			
120																									120			
140	0 -41																								140			
160	0 -46	0 -41	0 -23	0 -15																					160			
180																									180			
200	0 -51		0 -25	0 -18																					200			
250	0 -76	0 -46																							250			
300																									300			
350	0 -102	0 -51																							350			
400																									400			

[Notes] Division I is for deep groove type ball bearings.
Division II is for angular contact type and four-point contact type ball bearings.

Table 2 Standard radial internal clearance of deep groove and four-point contact type ball bearings Unit : μm

Bore diameter number	Radial internal clearance				
	classes K0, K1, K2		class K3	class K4	class K6
	Deep groove type	Four-point contact type			
010	25 – 41	25 – 38	18 – 28	13 – 23	10 – 20
015	30 – 46	30 – 43	20 – 30		13 – 23
020	30 – 61	30 – 56	20 – 46	15 – 30	10 – 25
025					15 – 30
030	15 – 30				
035	41 – 71	41 – 66	25 – 51	20 – 36	15 – 30
040					15 – 30
042					15 – 30
045	15 – 30				
047	51 – 86	51 – 76	30 – 56	20 – 36	15 – 30
050					15 – 30
055					15 – 30
060					15 – 30
065					15 – 30
070	61 – 107	61 – 86	36 – 61	25 – 41	15 – 30
075					15 – 30
080					15 – 30
090					15 – 30
100	71 – 122	71 – 97	41 – 66	25 – 41	15 – 30
110					15 – 30
120	15 – 30				
140	81 – 132	46 – 71	30 – 46	30 – 46	15 – 30
160	91 – 142	81 – 107	51 – 76	36 – 51	15 – 30
180					15 – 30
200	102 – 152	61 – 86	36 – 56	36 – 56	15 – 30
250	152 – 203	91 – 117			15 – 30
300					15 – 30
350	203 – 254	102 – 127			15 – 30
400					15 – 30

Table 3 Mounting dimensions

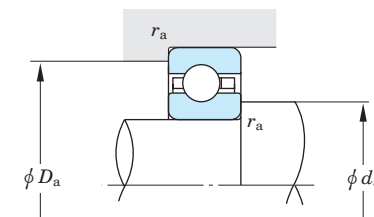

Unit : mm

Dimension series	Bearing type			ϕd_a		ϕD_a		r_a
				max.	min.	min.	max.	max.
T	KTC	KTA	KTX	$d + 5.3$	$d + 3.4$	$d + 4.2$	$d + 6.1$	0.2
A	KAC	KAA	KAX	$d + 7.3$	$d + 4.6$	$d + 5.4$	$d + 8.2$	0.4
B	KBC	KBA	KBX	$d + 9.3$	$d + 5.7$	$d + 6.6$	$d + 10.2$	0.8
C	KCC	KCA	KCX	$d + 11.3$	$d + 6.9$	$d + 7.7$	$d + 12.2$	0.8
D	KDC	KDA	KDX	$d + 15.3$	$d + 9.2$	$d + 10.1$	$d + 16.2$	1.3
F	KFC	KFA	KFX	$d + 23.3$	$d + 13.9$	$d + 14.8$	$d + 24.2$	1.8
G	KGC	KGA	KGX	$d + 31.3$	$d + 18.7$	$d + 19.5$	$d + 32.1$	1.8
J	-	KJA	-	$d + 11.3$	$d + 6.9$	$d + 7.7$	$d + 12.2$	0.2
U	KUC	-	KUX					

Table 4 Shaft diameter and housing bore diameter tolerance

Bore diameter number	Inner ring rotation										Outer ring rotation										Bore diameter number
	Shaft diameter tolerance					Housing bore diameter tolerance					Shaft diameter tolerance					Housing bore diameter tolerance					
	classes K0, K1, K2		class K3	class K4	class K6	classes K0, K1, K2		class K3	class K4	class K6	classes K0, K1, K2		class K3	class K4	class K6	classes K0, K1, K2		class K3	class K4	class K6	
	div. I	div. II				div. I	div. II				div. I	div. II				div. I	div. II				
010	+10 0	+5 0	+5 0	+4 0	+13 0		+8 0	+5 0			-10 -20	-5 -10	-5 -10	-4 -8	-13 -25		-8 -15	-5 -10		010	
015	+13 0	+8 0				+13 0			+5 0										-5 -10	015	
020				+5 0																020	
025	+15 0	+10 0					+10 0	+8 0			-15 -30	-10 -20		-5 -10						025	
030					+15 0		+10 0								-15 -30		-10 -20	-8 -15		030	
035			+8 0			+15 0							-8 -15							035	
040	+20 0	+13 0		+6 0							-20 -40	-13 -25		-6 -13						040	
042																				042	
045					+20 0		+13 0	+10 0							-20 -40		-13 -25	-10 -20		045	
047																				047	
050																				050	
055	+25 0	+15 0	+10 0	+8 0							-25 -50	-15 -30	-10 -20	-8 -15	-25 -50		-15 -30		-10 -20	055	
060					+25 0		+15 0		+10 0											060	
065																				065	
070																				070	
075					+30 0		+18 0	+13 0							-30 -60		-18 -35	-13 -25		075	
080	+30 0	+18 0		+10 0										-10 -20						080	
090			+13 0																	090	
100																				100	
110	+35 0	+35 0	+20 0		+35 0	+35 0	+20 0		+13 0		-35 -70	-35 -70	-20 -40	-13 -25	-35 -70	-35 -70	-20 -40		-13 -25	110	
120				+13 0																120	
140	+40 0				+40 0		+23 0	+15 0	+15 0		-48 -80				-40 -80		-23 -45	-15 -30	-15 -30	140	
160	+45 0	+40 0	+23 0	+15 0		+45 0	+40 0	+25 0	+18 0		-45 -90	-40 -80	-23 -45	-15 -30	-45 -90	-40 -80	-25 -50	-18 -35		160	
180																				180	
200	+50 0		+25 0	+18 0		+50 0	+45 0	+30 0	+20 0		-50 -100		-25 -50	-15 -35	-50 -100		-30 -60	-18 -40		200	
250	+75 0	+45 0				+75 0	+45 0													250	
300																				300	
350	+100 0	+50 0				+100 0	+50 0													350	
400																				400	

[Notes] Division I is for deep groove type ball bearings.
Division II is for angular contact type and four-point contact type ball bearings.

K-series super thin section ball bearings
open type

d 25.4 ~ (114.3) mm

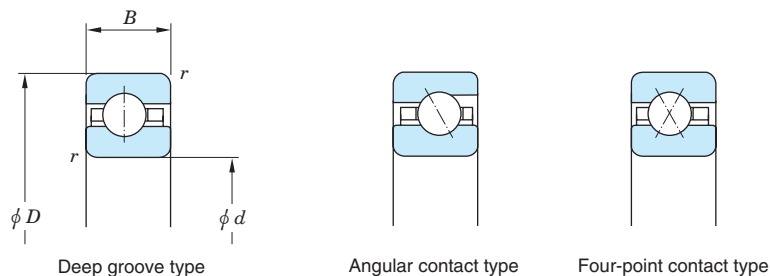

Boundary dimensions (mm)				Deep groove type			Angular contact type					Four-point contact type					(Refer.) Mass (kg)			
<i>d</i>	<i>D</i>	<i>B</i>	<i>r</i> min.	Bearing No.	Basic load ratings (kN)		Bearing No.	Basic load ratings (kN)				Bearing No.	Basic load ratings (kN)				Deep groove type	Angular contact type	Four-point contact type	
					<i>C_r</i>	<i>C_{0r}</i>		<i>C_r</i>	<i>C_{0r}</i>	<i>C_a</i>	<i>C_{0a}</i>		<i>C_r</i>	<i>C_{0r}</i>	<i>C_a</i>	<i>C_{0a}</i>				
25.4	34.925	4.762	0.4	KTC010	2.50	1.95	KTA010	2.65	2.20	3.45	6.70	KTX010	2.15	1.65	3.70	7.15	0.012	0.011	0.012	
38.1	47.625	4.762	0.4	KTC015	2.90	2.70	KTA015	3.05	3.10	4.00	9.35	KTX015	2.50	2.30	4.20	10.5	0.018	0.017	0.018	
50.8	63.5	6.35	0.6	KAC020	4.50	4.30	KAA020	4.75	4.95	6.25	14.9	KAX020	3.90	3.70	6.60	16.9	0.045	0.045	0.045	
			66.675		7.938	1		KBC020	6.35	5.85	KBA020		6.75	6.70	8.90	20.4	KBX020	5.55	5.00	9.35
63.5	76.2	6.35	0.6	KAC025	4.85	5.20	KAA025	5.10	5.95	6.75	18.0	KAX025	4.20	4.45	7.05	20.9	0.059	0.054	0.059	
			79.375		7.938	1		KBC025	6.90	7.00	KBA025		7.35	8.15	9.65	24.6	KBX025	6.00	6.00	10.0
76.2	88.9	6.35	0.6	KAC030	5.20	6.10	KAA030	5.45	7.00	7.15	21.2	KAX030	4.50	5.25	7.45	24.9	0.068	0.064	0.068	
			92.075		7.938	1		KBC030	7.35	8.15	KBA030		7.70	9.35	10.2	28.3	KBX030	6.35	7.00	10.6
88.9	101.6	6.35	0.6	KAC035	5.45	7.00	KAA035	5.75	8.00	7.55	24.3	KAX035	4.75	6.00	7.80	29.0	0.082	0.077	0.082	
			104.775		7.938	1		KBC035	7.75	9.30	KBA035		8.20	10.7	10.8	32.5	KBX035	6.70	8.00	11.1
101.6	114.3	6.35	0.6	KAC040	5.75	7.85	KAA040	6.00	9.05	7.90	27.4	KAX040	4.95	6.80	8.10	33.0	0.086	0.086	0.086	
			117.475		7.938	1		KBC040	8.10	10.5	KBA040		8.60	12.1	11.3	36.8	KBX040	7.05	9.00	11.6
		120.65	9.525	1	KCC040	10.3	12.4	KCA040	11.2	14.9	14.7	45.1	KCX040	8.95	10.6	14.8	50.0	0.204	0.200	0.204
		127		12.7		1.5	KDC040		15.7	17.2	KDA040	16.5		19.7	21.7	59.8	KDX040	13.6	14.8	22.6
		139.7	19.05	2	KFC040	28.2	28.1	KFA040	30.3	32.9	39.8	99.6	KFX040	24.6	24.0	41.0	103	0.862	0.871	0.862
		152.4		25.4		2	KGC040		42.6	39.6	KGA040	45.2		46.0	59.5	139	KGX040	37.3	34.5	62.4
107.95	120.65	6.35	0.6	KAC042	5.85	8.30	KAA042	6.15	9.55	8.10	29.0	KAX042	5.10	7.15	8.25	35.0	0.091	0.091	0.091	
			123.825		7.938	1		KBC042	8.25	10.9	KBA042		8.75	12.7	11.5	38.6	KBX042	7.15	9.40	11.7
		127	9.525	1	KCC042	10.5	13.0	KCA042	11.5	15.8	15.1	47.8	KCX042	9.15	11.2	15.0	53.0	0.213	0.209	0.213
		133.35		12.7		1.5	KDC042		15.8	17.8	KDA042	16.8		20.8	22.1	62.9	KDX042	13.7	15.3	22.8
		146.05	19.05	2	KFC042	28.8	29.4	KFA042	30.6	34.0	40.3	103	KFX042	25.1	25.2	41.8	109	0.907	0.925	0.907
		158.75		25.4		2	KGC042		42.2	39.9	KGA042	46.2		48.0	60.8	146	KGX042	36.9	34.3	61.8
114.3	127	6.35	0.6	KAC045	6.00	8.75	KAA045	6.25	10.1	8.25	30.5	KAX045	5.20	7.55	8.40	37.0	0.100	0.095	0.100	
			130.175		7.938	1		KBC045	8.45	11.6	KBA045		8.90	13.3	11.7	40.4	KBX045	7.35	10.0	12.0
		133.35	9.525	1	KCC045	10.7	13.7	KCA045	11.7	16.6	15.4	50.4	KCX045	9.30	11.8	15.3	56.1	0.218	0.222	0.218
		139.7		12.7		1.5	KDC045		16.3	19.0	KDA045	17.2		21.8	22.6	66.0	KDX045	14.2	16.3	23.4

K-series super thin section ball bearings
open type

d (114.3) ~ (165.1) mm

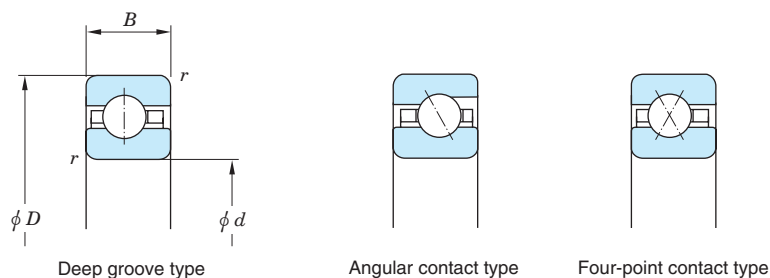

Boundary dimensions (mm)				Deep groove type				Angular contact type				Four-point contact type				(Refer.) Mass (kg)			
d	D	B	r min.	Bearing No.	Basic load ratings (kN)		Bearing No.	Basic load ratings (kN)			Bearing No.	Basic load ratings (kN)			Deep groove type	Angular contact type	Four-point contact type		
					C_r	C_{0r}		C_r	C_{0r}	C_a		C_{0a}	C_r	C_{0r}				C_a	C_{0a}
114.3	152.4	19.05	2	KFC045	29.4	30.8	KFA045	31.7	36.4	41.7	110	KFX045	25.6	26.3	42.6	115	0.953	0.971	0.953
	165.1	25.4	2	KGC045	43.6	42.7	KGA045	47.1	50.1	62.0	152	KGX045	38.1	36.4	63.6	152	1.81	1.79	1.81
120.65	133.35	6.35	0.6	KAC047	6.10	9.20	KAA047	6.40	10.6	8.40	32.1	KAX047	5.30	7.95	8.55	39.0	0.104	0.100	0.104
	136.525	7.938	1	KBC047	8.55	12.1	KBA047	9.10	14.2	12.0	42.9	KBX047	7.45	10.4	12.1	50.4	0.154	0.159	0.154
	139.7	9.525	1	KCC047	10.9	14.4	KCA047	12.0	17.5	15.7	53.0	KCX047	9.50	12.4	15.5	59.1	0.227	0.231	0.227
	146.05	12.7	1.5	KDC047	16.5	19.6	KDA047	17.5	22.8	23.0	69.1	KDX047	14.3	16.8	23.6	78.2	0.426	0.422	0.426
	158.75	19.05	2	KFC047	29.9	32.1	KFA047	32.0	37.5	42.2	114	KFX047	26.1	27.5	43.3	121	0.998	1.03	0.998
	171.45	25.4	2	KGC047	44.9	45.2	KGA047	48.0	52.1	63.1	158	KGX047	39.2	38.6	65.4	162	1.86	1.89	1.86
127	139.7	6.35	0.6	KAC050	6.20	9.65	KAA050	6.50	11.1	8.55	33.6	KAX050	5.35	8.35	8.65	41.1	0.109	0.104	0.109
	142.875	7.938	1	KBC050	8.80	12.8	KBA050	9.25	14.8	12.2	44.7	KBX050	7.60	11.0	12.4	53.6	0.172	0.168	0.172
	146.05	9.525	1	KCC050	11.1	15.0	KCA050	12.2	18.4	16.0	55.7	KCX050	9.65	12.9	15.8	62.1	0.263	0.245	0.263
	152.4	12.7	1.5	KDC050	16.9	20.8	KDA050	17.8	23.8	23.4	72.2	KDX050	14.7	17.9	24.2	83.5	0.454	0.445	0.454
	165.1	19.05	2	KFC050	30.5	33.4	KFA050	32.4	38.6	42.6	117	KFX050	26.5	28.7	44.0	127	1.04	1.08	1.04
	177.8	25.4	2	KGC050	46.2	47.6	KGA050	48.8	54.2	64.3	164	KGX050	40.3	40.7	67.1	173	1.95	2.00	1.95
139.7	152.4	6.35	0.6	KAC055	6.40	10.5	KAA055	6.75	12.1	8.85	36.8	KAX055	5.55	9.10	8.90	45.1	0.113	0.113	0.113
	155.575	7.938	1	KBC055	9.10	13.9	KBA055	9.60	16.2	12.6	49.0	KBX055	7.85	12.0	12.7	58.8	0.186	0.181	0.186
	158.75	9.525	1	KCC055	11.5	16.4	KCA055	12.5	19.8	16.5	60.0	KCX055	10.0	14.1	16.2	68.2	0.268	0.263	0.268
	165.1	12.7	1.5	KDC055	17.5	22.6	KDA055	18.4	25.9	24.2	78.5	KDX055	15.2	19.4	24.9	91.6	0.481	0.481	0.481
	177.8	19.05	2	KFC055	31.5	36.1	KFA055	33.6	42.1	44.3	128	KFX055	27.4	31.0	45.3	140	1.13	1.17	1.13
	190.5	25.4	2	KGC055	47.0	49.8	KGA055	50.5	58.3	66.4	177	KGX055	41.0	42.6	68.0	184	2.13	2.15	2.13
152.4	165.1	6.35	0.6	KAC060	6.60	11.4	KAA060	6.95	13.2	9.15	39.9	KAX060	5.75	9.85	9.15	49.1	0.127	0.127	0.127
	168.275	7.938	1	KBC060	9.35	15.1	KBA060	9.90	17.6	13.0	53.3	KBX060	8.10	13.0	13.1	64.1	0.200	0.200	0.200
	171.45	9.525	1	KCC060	11.9	17.7	KCA060	12.9	21.5	17.0	65.3	KCX060	10.3	15.3	16.7	74.2	0.286	0.290	0.286
	177.8	12.7	1.5	KDC060	18.0	24.4	KDA060	19.0	27.9	24.9	84.7	KDX060	15.7	21.0	25.5	99.7	0.526	0.522	0.526
	190.5	19.05	2	KFC060	32.5	38.8	KFA060	34.8	45.6	45.8	138	KFX060	28.2	33.3	46.5	152	1.22	1.23	1.22
	203.2	25.4	2	KGC060	49.3	54.7	KGA060	52.0	62.4	68.4	189	KGX060	42.9	46.8	71.1	205	2.31	2.30	2.31
165.1	177.8	6.35	0.6	KAC065	6.80	12.3	KAA065	7.15	14.2	9.40	43.0	KAX065	5.90	10.6	9.40	53.2	0.136	0.136	0.136
	180.975	7.938	1	KBC065	9.65	16.3	KBA065	10.1	18.8	13.3	56.9	KBX065	8.35	14.0	13.4	69.3	0.213	0.213	0.213

K-series super thin section ball bearings
open type

d (165.1) ~ 228.6 mm

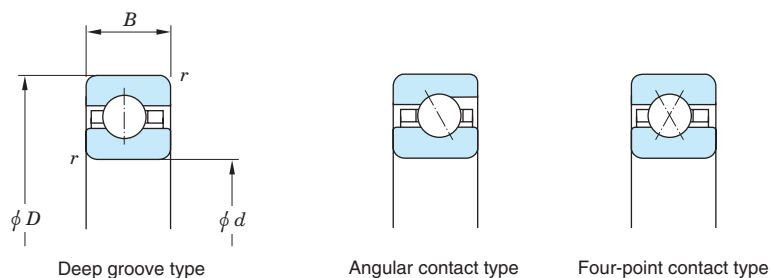

Boundary dimensions (mm)				Deep groove type				Angular contact type				Four-point contact type				(Refer.) Mass (kg)			
<i>d</i>	<i>D</i>	<i>B</i>	<i>r</i> min.	Bearing No.	Basic load ratings (kN)		Bearing No.	Basic load ratings (kN)			Bearing No.	Basic load ratings (kN)			Deep groove type	Angular contact type	Four-point contact type		
					<i>C_r</i>	<i>C_{0r}</i>		<i>C_r</i>	<i>C_{0r}</i>	<i>C_a</i>		<i>C_{0a}</i>	<i>C_r</i>	<i>C_{0r}</i>				<i>C_a</i>	<i>C_{0a}</i>
165.1	184.15	9.525	1	KCC065	12.2	19.0	KCA065	13.4	23.3	17.6	70.6	KCX065	10.6	16.4	17.1	80.3	0.308	0.308	0.308
	190.5	12.7	1.5	KDC065	18.6	26.1	KDA065	19.5	30.0	25.6	90.9	KDX065	16.1	22.5	26.2	108	0.553	0.562	0.553
	203.2	19.05	2	KFC065	33.4	41.5	KFA065	36.0	49.1	47.3	149	KFX065	29.0	35.6	47.7	164	1.32	1.33	1.32
	215.9	25.4	2	KGC065	50.0	57.0	KGA065	53.5	66.5	70.3	202	KGX065	43.5	48.8	71.8	216	2.45	2.45	2.45
177.8	190.5	6.35	0.6	KAC070	7.00	13.2	KAA070	7.35	15.2	9.65	46.1	KAX070	6.05	11.4	9.60	57.2	0.141	0.145	0.141
	193.675	7.938	1	KBC070	9.90	17.4	KBA070	10.4	20.2	13.7	61.2	KBX070	8.55	15.0	13.7	74.6	0.227	0.227	0.227
	196.85	9.525	1	KCC070	12.5	20.4	KCA070	13.6	24.7	17.9	74.9	KCX070	10.9	17.6	17.5	86.3	0.331	0.336	0.331
	203.2	12.7	1.5	KDC070	19.0	27.9	KDA070	20.0	32.1	26.3	97.2	KDX070	16.5	24.0	26.7	116	0.594	0.603	0.594
	215.9	19.05	2	KFC070	34.3	44.1	KFA070	37.0	52.6	48.7	159	KFX070	29.8	37.9	48.7	176	1.45	1.43	1.45
	228.6	25.4	2	KGC070	52.1	61.8	KGA070	54.8	70.7	72.2	214	KGX070	45.3	53.0	74.5	237	2.63	2.66	2.63
	190.5	203.2	6.35	0.6	KAC075	7.15	14.1	KAA075	7.50	16.2	9.90	49.2	KAX075	6.20	12.2	9.80	61.3	0.154	0.154
206.375		7.938	1	KBC075	10.1	18.6	KBA075	10.7	21.6	14.1	65.4	KBX075	8.80	16.0	14.0	79.8	0.240	0.245	0.240
209.55		9.525	1	KCC075	12.8	21.7	KCA075	14.0	26.5	18.4	80.2	KCX075	11.1	18.7	17.8	92.4	0.354	0.354	0.354
215.9		12.7	1.5	KDC075	19.5	29.7	KDA075	20.5	34.1	27.0	103	KDX075	16.9	25.6	27.3	124	0.640	0.644	0.640
228.6		19.05	2	KFC075	35.1	46.8	KFA075	37.5	54.8	49.3	166	KFX075	30.5	40.2	49.8	188	1.54	1.54	1.54
241.3		25.4	2	KGC075	52.6	64.1	KGA075	56.2	74.8	73.9	227	KGX075	45.8	55.0	75.2	249	2.77	2.81	2.77
203.2	215.9	6.35	0.6	KAC080	7.35	15.0	KAA080	7.70	17.3	10.1	52.3	KAX080	6.35	13.0	10.0	65.3	0.172	0.163	0.172
	219.075	7.938	1	KBC080	10.4	19.7	KBA080	11.0	23.0	14.4	69.7	KBX080	9.00	17.0	14.3	85.1	0.259	0.259	0.259
	222.25	9.525	1	KCC080	13.1	23.1	KCA080	14.4	28.2	18.9	85.5	KCX080	11.4	19.9	18.2	98.5	0.381	0.381	0.381
	228.6	12.7	1.5	KDC080	20.0	31.5	KDA080	21.0	36.2	27.6	110	KDX080	17.3	27.1	27.9	132	0.694	0.689	0.694
	241.3	19.05	2	KFC080	35.9	49.5	KFA080	38.5	58.3	50.6	177	KFX080	31.2	42.5	50.7	200	1.59	1.64	1.59
	254	25.4	2	KGC080	54.5	69.0	KGA080	57.4	78.9	75.5	239	KGX080	47.4	59.2	77.6	270	2.95	2.97	2.95
228.6	241.3	6.35	0.6	KAC090	7.65	16.8	KAA090	8.00	19.3	10.5	58.6	KAX090	6.60	14.5	10.4	73.4	0.200	0.186	0.200
	244.475	7.938	1	KBC090	10.8	22.1	KBA090	11.4	25.6	15.0	77.6	KBX090	9.35	19.1	14.8	95.6	0.299	0.290	0.299
	247.65	9.525	1	KCC090	13.7	25.7	KCA090	14.9	31.4	19.6	95.1	KCX090	11.9	22.2	18.9	111	0.426	0.445	0.426
	254	12.7	1.5	KDC090	20.8	35.0	KDA090	21.8	40.3	28.7	122	KDX090	18.0	30.2	28.9	148	0.780	0.767	0.780
	266.7	19.05	2	KFC090	37.4	54.8	KFA090	40.3	65.3	53.1	198	KFX090	32.5	47.2	52.6	224	1.77	1.79	1.77
	279.4	25.4	2	KGC090	56.8	76.1	KGA090	59.8	87.1	78.7	264	KGX090	49.4	65.3	80.5	302	3.27	3.27	3.27

K-series super thin section ball bearings
open type

d 254 ~ 406.4 mm

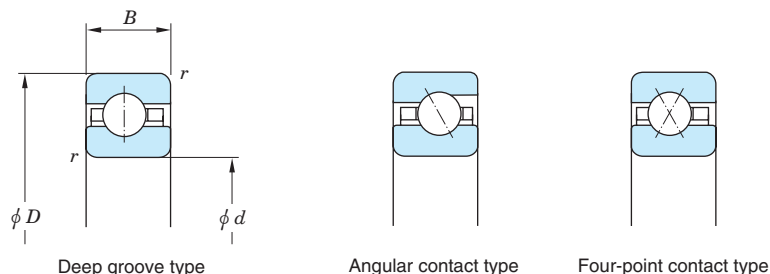

Boundary dimensions (mm)				Deep groove type			Angular contact type				Four-point contact type				(Refer.) Mass (kg)				
<i>d</i>	<i>D</i>	<i>B</i>	<i>r</i> min.	Bearing No.	Basic load ratings (kN)		Bearing No.	Basic load ratings (kN)			Bearing No.	Basic load ratings (kN)			Deep groove type	Angular contact type	Four-point contact type		
					<i>C_r</i>	<i>C_{0r}</i>		<i>C_r</i>	<i>C_{0r}</i>	<i>C_a</i>		<i>C_{0a}</i>	<i>C_r</i>	<i>C_{0r}</i>				<i>C_a</i>	<i>C_{0a}</i>
254	266.7	6.35	0.6	KAC100	7.95	18.6	KAA100	8.30	21.4	11.0	64.8	KAX100	6.85	16.0	10.7	81.4	0.227	0.204	0.227
	269.875	7.938	1	KBC100	11.2	24.4	KBA100	11.9	28.4	15.6	86.1	KBX100	9.75	21.1	15.3	106	0.331	0.322	0.331
	273.05	9.525	1	KCC100	14.2	28.4	KCA100	15.6	34.9	20.5	106	KCX100	12.3	24.5	19.5	123	0.481	0.472	0.481
	279.4	12.7	1.5	KDC100	21.6	38.6	KDA100	22.7	44.4	29.8	135	KDX100	18.7	33.3	29.8	164	0.853	0.848	0.853
	292.1	19.05	2	KFC100	38.8	60.2	KFA100	41.6	71.1	54.7	215	KFX100	33.7	51.8	54.3	249	1.95	2.00	1.95
	304.8	25.4	2	KGC100	59.0	83.2	KGA100	62.0	95.3	81.6	289	KGX100	51.2	71.5	83.1	334	3.58	3.63	3.58
279.4	292.1	6.35	0.6	KAC110	8.20	20.3	KAA110	8.60	23.4	11.3	71.0	KAX110	7.10	17.6	11.1	89.5	0.236	0.227	0.236
	295.275	7.938	1	KBC110	11.6	26.7	KBA110	12.3	31.0	16.1	94.0	KBX110	10.1	23.1	15.7	117	0.340	0.354	0.340
	298.45	9.525	1	KCC110	14.7	31.1	KCA110	16.1	38.0	21.1	115	KCX110	12.7	26.8	20.1	135	0.526	0.517	0.526
	304.8	12.7	1.5	KDC110	22.3	42.2	KDA110	23.4	48.5	30.8	147	KDX110	19.3	36.4	30.7	180	0.934	0.930	0.934
	317.5	19.05	2	KFC110	40.2	65.5	KFA110	43.2	78.0	56.9	236	KFX110	34.8	56.4	55.9	273	2.18	2.15	2.18
	330.2	25.4	2	KGC110	61.0	90.3	KGA110	64.1	104	84.3	314	KGX110	52.9	77.7	85.5	366	3.90	3.94	3.90
304.8	317.5	6.35	0.6	KAC120	8.45	22.1	KAA120	8.90	25.5	11.7	77.3	KAX120	7.35	19.1	11.4	97.6	0.254	0.245	0.254
	320.675	7.938	1	KBC120	12.0	29.0	KBA120	12.7	33.8	16.7	103	KBX120	10.4	25.1	16.2	127	0.376	0.386	0.376
	323.85	9.525	1	KCC120	15.2	33.8	KCA120	16.5	41.2	21.8	125	KCX120	13.1	29.2	20.6	147	0.567	0.558	0.567
	330.2	12.7	1.5	KDC120	23.0	45.7	KDA120	24.2	52.6	31.8	160	KDX120	20.0	39.5	31.5	197	1.02	1.01	1.02
	342.9	19.05	2	KFC120	41.4	70.9	KFA120	44.3	83.8	58.3	254	KFX120	35.9	61.1	57.4	297	2.36	2.36	2.36
	355.6	25.4	2	KGC120	62.9	97.5	KGA120	66.0	112	86.9	339	KGX120	54.5	83.9	87.8	399	4.22	4.30	4.22
355.6	371.475	7.938	1	KBC140	12.7	33.7	KBA140	13.4	39.1	17.6	118	KBX140	11.0	29.1	17.0	148	0.476	0.445	0.476
	374.65	9.525	1	KCC140	16.0	39.1	KCA140	17.5	47.9	23.0	145	KCX140	13.9	33.8	21.6	171	0.689	0.649	0.689
	381	12.7	1.5	KDC140	24.3	52.9	KDA140	25.5	60.9	33.6	184	KDX140	21.1	45.7	33.1	229	1.24	1.17	1.24
	393.7	19.05	2	KFC140	43.7	81.5	KFA140	46.8	96.5	61.6	293	KFX140	37.9	70.3	60.2	345	2.72	2.61	2.72
	406.4	25.4	2	KGC140	66.3	112	KGA140	69.7	128	91.7	389	KGX140	57.5	96.2	92.0	463	4.90	4.94	4.90
	406.4	422.275	7.938	1	KBC160	13.3	38.3	KBA160	14.0	44.5	18.4	135	KBX160	11.5	33.1	17.7	169	0.544	0.508
425.45		9.525	1	KCC160	16.8	44.4	KCA160	18.4	54.5	24.2	165	KCX160	14.6	38.4	22.6	195	0.785	0.739	0.785
431.8		12.7	1.5	KDC160	25.5	60.0	KDA160	26.8	69.1	35.2	209	KDX160	22.1	51.8	34.5	261	1.41	1.33	1.41
444.5		19.05	2	KFC160	45.8	92.2	KFA160	49.0	109	64.5	331	KFX160	39.7	79.6	62.7	394	3.22	3.08	3.22
457.2		25.4	2	KGC160	69.5	126	KGA160	73.0	145	96.0	439	KGX160	60.3	109	95.9	528	5.58	5.62	5.58

K-series super thin section ball bearings
open type

d 457.2 ~ 1 016 mm

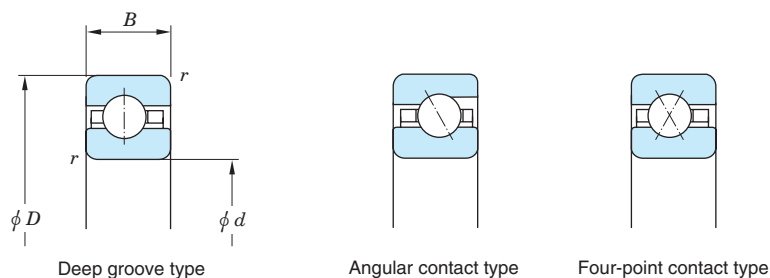

Boundary dimensions (mm)				Deep groove type			Angular contact type					Four-point contact type					(Refer.) Mass (kg)		
<i>d</i>	<i>D</i>	<i>B</i>	<i>r</i> min.	Bearing No.	Basic load ratings (kN)		Bearing No.	Basic load ratings (kN)				Bearing No.	Basic load ratings (kN)				Deep groove type	Angular contact type	Four-point contact type
					<i>C_r</i>	<i>C_{0r}</i>		<i>C_r</i>	<i>C_{0r}</i>	<i>C_a</i>	<i>C_{0a}</i>		<i>C_r</i>	<i>C_{0r}</i>	<i>C_a</i>	<i>C_{0a}</i>			
457.2	473.075	7.938	1	KBC180	13.9	42.9	KBA180	14.6	49.9	19.2	151	KBX180	12.0	37.1	18.4	190	0.612	0.572	0.612
	476.25	9.525	1	KCC180	17.5	49.8	KCA180	19.2	61.2	25.3	185	KCX180	15.2	43.0	23.4	220	0.880	0.830	0.880
	482.6	12.7	1.5	KDC180	26.6	67.1	KDA180	27.6	77.3	36.3	234	KDX180	23.0	58.0	35.8	293	1.58	1.49	1.58
	495.3	19.05	2	KFC180	47.8	103	KFA180	51.5	123	67.7	373	KFX180	41.4	88.8	65.0	442	3.58	3.48	3.58
	508	25.4	2	KGC180	72.5	140	KGA180	76.0	161	100	488	KGX180	62.8	121	99.4	592	6.21	6.26	6.21
508	523.875	7.938	1	KBC200	14.4	47.6	KBA200	15.2	55.3	20.0	168	KBX200	12.5	41.2	19.0	211	0.680	0.635	0.680
	527.05	9.525	1	KCC200	18.2	55.1	KCA200	19.9	67.5	26.2	205	KCX200	15.8	47.7	24.2	244	0.980	0.921	0.980
	533.4	12.7	1.5	KDC200	27.6	74.3	KDA200	29.0	85.6	38.1	259	KDX200	23.9	64.2	37.0	326	1.75	1.66	1.75
	546.1	19.05	2	KFC200	49.6	114	KFA200	53.4	136	70.3	412	KFX200	43.0	98.1	67.2	491	4.04	3.84	4.04
	558.8	25.4	2	KGC200	75.2	154	KGA200	78.9	178	104	538	KGX200	65.2	133	103	657	8.53	6.89	8.53
635	654.05	9.525	1	KCC250	19.7	68.5	KCA250	21.6	84.0	28.4	255	KCX250	17.1	59.2	26.0	304	1.22	1.14	1.22
	660.4	12.7	1.5	KDC250	29.9	92.1	KDA250	31.4	106	41.3	322	KDX250	25.9	79.6	39.7	407	2.17	2.06	2.17
	673.1	19.05	2	KFC250	53.7	140	KFA250	57.6	167	75.8	506	KFX250	46.5	121	72.0	612	4.94	4.76	4.94
	685.8	25.4	2	KGC250	81.4	190	KGA250	85.4	219	112	663	KGX250	70.5	164	110	819	8.85	8.53	8.85
762	781.05	9.525	1	KCC300	21.1	81.9	KCA300	23.1	101	30.3	305	KCX300	18.3	70.8	27.6	365	1.46	1.37	1.46
	787.4	12.7	1.5	KDC300	32.0	110	KDA300	33.5	127	44.1	384	KDX300	27.7	95.0	42.1	487	2.60	2.47	2.60
	800.1	19.05	2	KFC300	57.3	167	KFA300	61.6	200	81.0	605	KFX300	49.6	144	76.3	733	5.90	5.67	5.90
	812.8	25.4	2	KGC300	86.8	226	KGA300	91.1	260	120	788	KGX300	75.2	195	116	980	10.6	10.2	10.6
889	927.1	19.05	2	KFC350	60.6	194	KFA350	65.2	232	85.8	703	KFX350	52.5	168	80.1	854	6.85	6.62	6.85
	939.8	25.4	2	KGC350	91.7	261	KGA350	96.2	301	127	912	KGX350	79.4	226	122	1 140	12.3	11.9	12.3
1 016	1 054.1	19.05	2	KFC400	63.5	221	KFA400	68.4	264	90.0	801	KFX400	55.0	191	83.6	975	7.80	7.53	7.80
	1 066.8	25.4	2	KGC400	96.2	297	KGA400	101	342	133	1 040	KGX400	83.3	257	128	1 300	14.0	13.5	14.0

K-series super thin section ball bearings
sealed type

d 101.6 ~ 304.8 mm

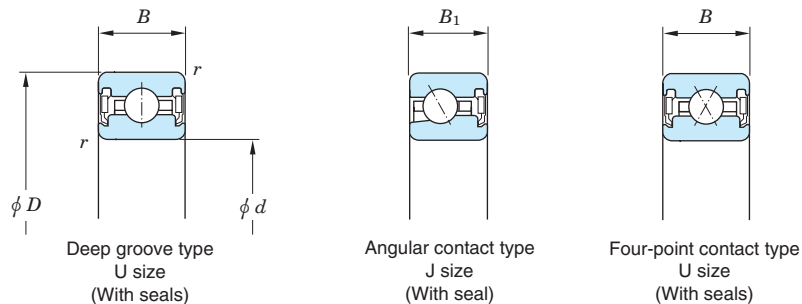

Boundary dimensions (mm)					Deep groove type			Angular contact type				Four-point contact type				(Refer.) Mass (kg)				
<i>d</i>	<i>D</i>	<i>B</i>	<i>B</i> ₁	<i>r</i> _{min.}	Bearing No.	Basic load ratings (kN)		Bearing No.	Basic load ratings (kN)				Bearing No.	Basic load ratings (kN)				Deep groove type	Angular contact type	Four-point contact type
						<i>C</i> _r	<i>C</i> _{0r}		<i>C</i> _r	<i>C</i> _{0r}	<i>C</i> _a	<i>C</i> _{0a}		<i>C</i> _r	<i>C</i> _{0r}	<i>C</i> _a	<i>C</i> _{0a}			
101.6	120.65	12.7	11.1	0.4	KUC040 2RD	10.3	12.4	KJA040 RD	11.2	14.9	14.7	45.1	KUX040 2RD	8.95	10.6	14.8	50.0	0.249	0.222	0.249
107.95	127	12.7	11.1	0.4	KUC042 2RD	10.5	13.0	KJA042 RD	11.5	15.8	15.1	47.8	KUX042 2RD	9.15	11.2	15.0	53.0	0.263	0.236	0.263
114.3	133.35	12.7	11.1	0.4	KUC045 2RD	10.7	13.7	KJA045 RD	11.7	16.6	15.4	50.4	KUX045 2RD	9.30	11.8	15.3	56.1	0.277	0.254	0.277
120.65	139.7	12.7	11.1	0.4	KUC047 2RD	10.9	14.4	KJA047 RD	12.0	17.5	15.7	53.0	KUX047 2RD	9.50	12.4	15.5	59.1	0.295	0.268	0.295
127	146.05	12.7	11.1	0.4	KUC050 2RD	11.1	15.0	KJA050 RD	12.2	18.4	16.0	55.7	KUX050 2RD	9.65	12.9	15.8	62.1	0.308	0.281	0.308
139.7	158.75	12.7	11.1	0.4	KUC055 2RD	11.5	16.4	KJA055 RD	12.5	19.8	16.5	60.0	KUX055 2RD	10.0	14.1	16.2	68.2	0.336	0.304	0.336
152.4	171.45	12.7	11.1	0.4	KUC060 2RD	11.9	17.7	KJA060 RD	12.9	21.5	17.0	65.3	KUX060 2RD	10.3	15.3	16.7	74.2	0.367	0.331	0.367
165.1	184.15	12.7	11.1	0.4	KUC065 2RD	12.2	19.0	KJA065 RD	13.4	23.3	17.6	70.6	KUX065 2RD	10.6	16.4	17.1	80.3	0.395	0.354	0.395
177.8	196.85	12.7	11.1	0.4	KUC070 2RD	12.5	20.4	KJA070 RD	13.6	24.7	17.9	74.9	KUX070 2RD	10.9	17.6	17.5	86.3	0.422	0.381	0.422
190.5	209.55	12.7	11.1	0.4	KUC075 2RD	12.8	21.7	KJA075 RD	14.0	26.5	18.4	80.2	KUX075 2RD	11.1	18.7	17.8	92.4	0.449	0.404	0.449
203.2	222.25	12.7	11.1	0.4	KUC080 2RD	13.1	23.1	KJA080 RD	14.4	28.2	18.9	85.5	KUX080 2RD	11.4	19.9	18.2	98.5	0.481	0.431	0.481
228.6	247.65	12.7	11.1	0.4	KUC090 2RD	13.7	25.7	KJA090 RD	14.9	31.4	19.6	95.1	KUX090 2RD	11.9	22.2	18.9	111	0.535	0.499	0.535
254	273.05	12.7	11.1	0.4	KUC100 2RD	14.2	28.4	KJA100 RD	15.6	34.9	20.5	106	KUX100 2RD	12.3	24.5	19.5	123	0.594	0.531	0.594
279.4	298.45	12.7	11.1	0.4	KUC110 2RD	14.7	31.1	KJA110 RD	16.1	38.0	21.1	115	KUX110 2RD	12.7	26.8	20.1	135	0.649	0.581	0.649
304.8	323.85	12.7	11.1	0.4	KUC120 2RD	15.2	33.8	KJA120 RD	16.5	41.2	21.8	125	KUX120 2RD	13.1	29.2	20.6	147	0.708	0.630	0.708

Bearings for machine tool spindles (for support of axial loading)

JTEKT supplies double direction angular contact thrust ball bearings and ACT type matched pair angular contact ball bearings which are used with machine tool spindles to support axial loading.

These bearings were developed to meet needs which have grown as machine tool spindle rotation has become faster and more accurate.

Several dimension series are available for selection according to operating conditions.

For details, refer to JTEKT separate catalog "Precision Ball and Roller Bearings for Machine Tools" (CAT. NO. B2005E).

See also the catalog for high ability bearings, CAT NO. B2006 for High Ability Ball Bearing Series Angular Contact Ball Bearings for Machining Tools.

Double direction angular contact thrust ball bearings



Bore diameter 25 – 340 mm

Matched pair angular contact ball bearing (ACT type)



Bore diameter 50 – 170 mm

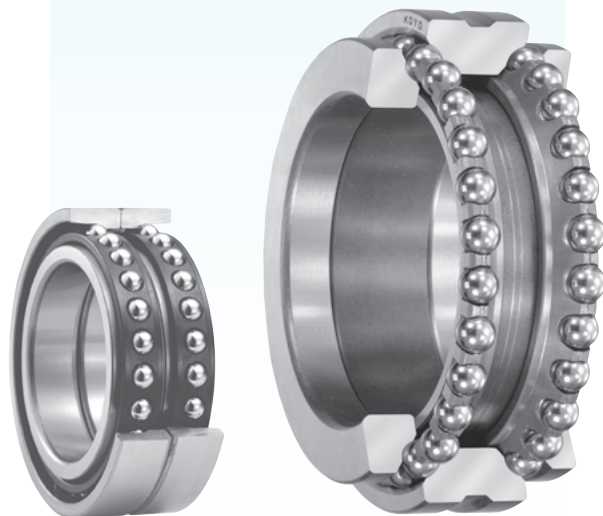

(Reference)

Major bearing types which are used to carry radial loading of machine tool spindles are shown below.

For further details, refer to the specification table for each type.

Angular contact ball bearings			Double-row cylindrical roller bearings	
(for high-speed applications)				
79 C 70, 70 B, 70 C 72, 72 B, 72 C	79 CPA 70 CPA 72 CPA	HAR 9 C HAR 0 C (high ability ball bearing)	NN 30 NN 30 K (Tapered bore)	NNU 49 NNU 49 K (Tapered bore)
Refer to p. B 92. (for bearings with ceramic balls, refer to p. C 21.)			Refer to p. B 194.	

Table 1 Bearing types for support of axial loading

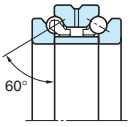
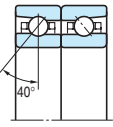
Type	Double direction angular contact thrust ball bearings		Matched pair angular contact ball bearings		Types of ¹⁾ arrangement with a double-row cylindrical roller bearing
					
Diameter series					
0	2344 B 2347 B	ACT 0 B DB —	ACT 0 DB —	① ②	
9	2394 B 2397 B	— —	— —	③ ④	
Characteristics	<ul style="list-style-type: none"> Supports axial loading in both directions. Highly rigid in the axial direction. Bearings with a larger contact angle feature higher rigidity, while those with a smaller contact angle feature better high-speed performance. 		<ul style="list-style-type: none"> For support of axial loading only. Negative tolerances are specified for the outside diameter. Excellent high-speed performance is achieved because of the small contact angle. Interchangeable with 2344 B series bearings.²⁾ 		—

[Notes]

1) These bearings are usually used in arrangement with a double-row cylindrical roller bearing which carries a radial load. There are four arrangement types (① to ④) as follows :

- ① Mounted with an NN30K tapered bore bearing or with an NN30 cylindrical bore bearing. The tapered bore bearing is combined at its smaller side.
- ② Mounted with an NN30K tapered bore bearing, which is combined at its larger side.
- ③ Mounted with an NNU49K tapered bore bearing or with an NNU49 cylindrical bore bearing. The tapered bore bearing is combined at its smaller side.
- ④ Mounted with an NNU49K tapered bore bearing, which is combined at its larger side.

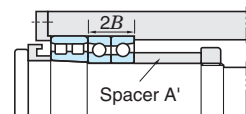
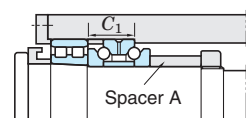

2) The overall width "2 B" of ACT0 DB and ACT0B DB bearings is equivalent to dimension "C₁" of 2344B bearings. Therefore, when a 2344B bearing is replaced with an ACT0 DB or ACT0B DB bearing, change the width of spacer "A" only. No change is necessary to the spindle or housing dimensions.

Table 2 Double direction angular contact thrust ball bearing tolerance

(1) Inner ring and assembled bearing width

Unit : μm

Nominal bore diameter <i>d</i> (mm)	Δ_{dmp} or $\Delta_{ds}^{1)}$		Actual bearing width deviation Δ_{Ts}		Inner ring width variation V_{Bs}		Perpendicularity of inner ring face with respect to the bore S_d		Assembled bearing inner ring face runout with raceway S_{ia}				
	class 5 or equivalent		class 4 or equivalent		classes 4 and 5, or equivalent		class 5 or equivalent	class 4 or equivalent	class 5 or equivalent	class 4 or equivalent			
	over	up to	upper	lower	upper	lower	upper	lower	max.	max.	max.		
18	30	0	-6	0	-5	0	-300	5	2.5	8	4	5	3
30	50	0	-8	0	-6	0	-400	5	3	8	4	5	3
50	80	0	-9	0	-7	0	-500	6	4	8	4	6	5
80	120	0	-10	0	-8	0	-600	7	4	9	5	6	5
120	180	0	-13	0	-10	0	-700	8	5	10	6	8	6
180	250	0	-15	0	-12	0	-800	10	6	11	7	8	6
250	315	0	-18	0	-15	0	-900	13	7	13	8	10	8
315	400	0	-23	0	-18	0	-1 000	15	9	15	9	13	10

(2) Outer ring

Unit : μm

Nominal outside diameter <i>D</i> (mm)	Δ_{Dmp} or $\Delta_{Ds}^{2)}$		Outer ring width variation V_{Cs}		Perpendicularity of outer ring outside surface with respect to the face S_D		Assembled bearing outer ring face runout with raceway S_{ea}	
	classes 5 and 4, or equivalent		class 5 or equivalent	class 4 or equivalent	class 5 or equivalent	class 4 or equivalent	classes 5 and 4, or equivalent	
	over	up to	upper	lower	max.		max.	
30	50	-30	-40	5	2.5	8	4	Shall conform to the tolerance S_{ia} on <i>d</i> of the same bearing
50	80	-40	-50	6	3	8	4	
80	120	-50	-60	8	4	9	5	
120	150	-60	-75	8	5	10	5	
150	180	-60	-75	8	5	10	5	
180	250	-75	-90	10	7	11	7	
250	315	-90	-105	11	7	13	8	
315	400	-110	-125	13	8	13	10	
400	500	-120	-140	15	10	15	13	

[Notes] 1) Single plane mean bore diameter deviation or single bore diameter deviation

2) Single plane mean outside diameter deviation or single outside diameter deviation

Table 3 ACT 0 series angular contact ball bearing outside diameter tolerance Unit : μm

Nominal outside diameter <i>D</i> (mm)		Single outside diameter deviation Δ_{Ds}	
over	up to	upper	lower
50	80	-32	-47
80	120	-39	-56
120	150	-44	-66
150	180	-44	-68
180	250	-51	-79
250	315	-56	-89

[Remark] Refer to JIS B 1514 "radial bearing tolerance" class 4 and class 5 (pp. A 54 to A 57, Table 7-3) for the accuracy of dimensions other than outside diameter and for running accuracy.

[Reference] Axial load and axial displacement

The relationship between axial loading and the axial displacement of double direction angular contact thrust ball bearings and ACT type angular contact ball bearings is shown below :

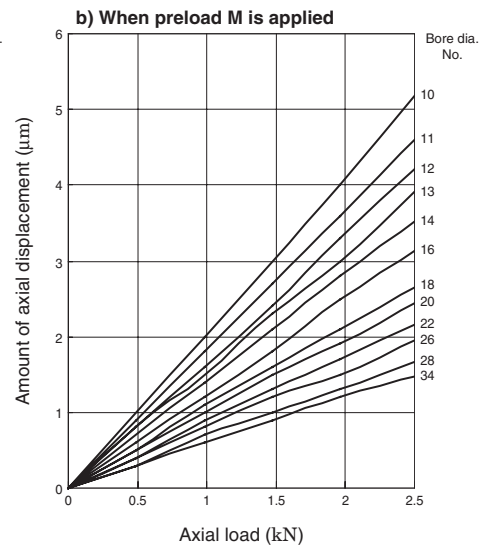
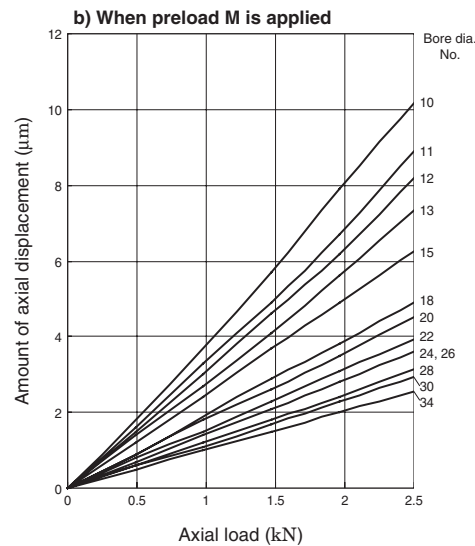
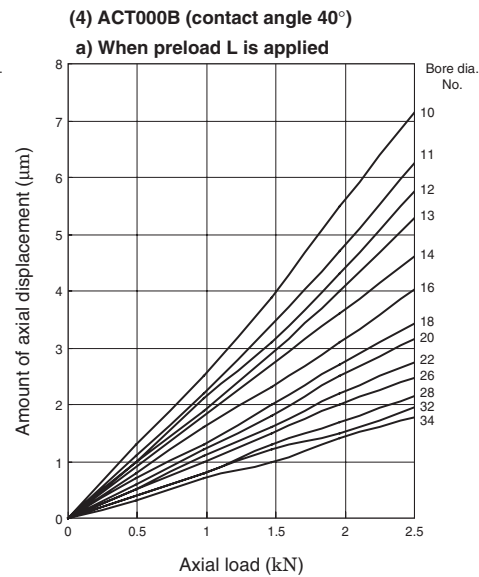
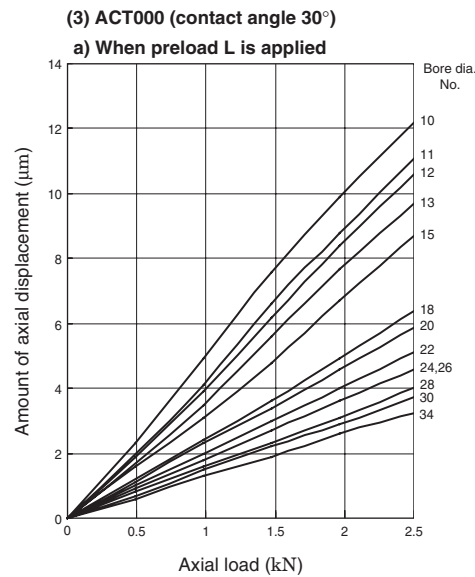
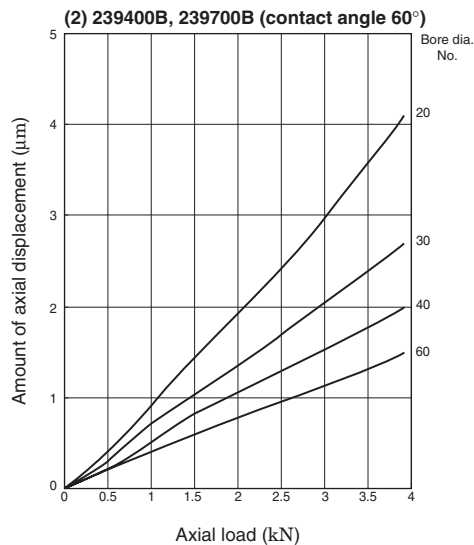
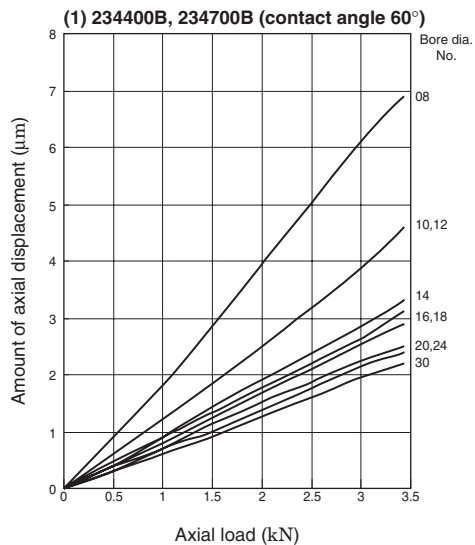

Double direction angular contact thrust ball bearings

d 25 ~ 105 mm

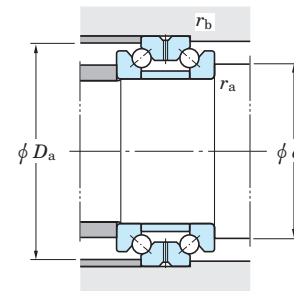
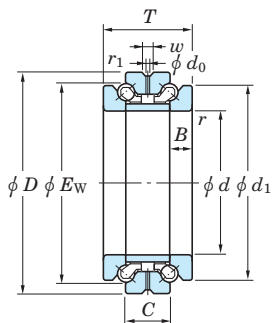

d Small bore type Large bore type	Boundary dimensions (mm)						Basic load ratings (kN)		Limiting speeds (min ⁻¹)		Bearing No.		Dimensions (mm)					Mounting dimensions (mm)				Amount of grease fill (cm ³ /row)		(Refer.) Mass (kg)	
	D	T	C	r min.	r ₁ min.	C _a	C _{0a}	Grease lub.	Oil lub.	Small bore type	Large bore type	E _w ¹⁾	d ₁	B	d ₀	w	d _a min.	D _a max.	r _a max.	r _b max.	Small bore type	Large bore type			
25	—	47	28	14	0.6	0.3	13.2	19.9	7 700	11 000	234405B	—	41.3	40	7	2	4.5	33	44	0.6	0.3	0.18 ~ 0.26	0.194	—	
30	32	55	32	16	1	0.6	14.0	23.6	6 700	9 500	234406B	234706B	48.5	47	8	2	4.5	40	50.5	1	0.6	0.30 ~ 0.45	0.296	0.272	
35	37	62	34	17	1	0.6	20.8	34.8	6 100	8 700	234407B	234707B	55	53	8.5	2	4.5	45.5	57.5	1	0.6	0.40 ~ 0.60	0.388	0.357	
40	42	68	36	18	1	0.6	23.9	41.7	5 700	8 100	234408B	234708B	61	58.5	9	2	4.5	50	63.5	1	0.6	0.50 ~ 0.75	0.475	0.437	
45	47	75	38	19	1	0.6	26.0	50.1	5 200	7 500	234409B	234709B	67.5	65	9.5	2	4.5	56.5	70.5	1	0.6	0.65 ~ 0.98	0.602	0.554	
50	52	80	38	19	1	0.6	26.8	54.4	5 100	7 300	234410B	234710B	72.5	70	9.5	2	4.5	61.5	75.5	1	0.6	0.70 ~ 1.1	0.654	0.602	
55	57	90	44	22	1.1	0.6	37.2	71.7	4 400	6 400	234411B	234711B	81	78	11	4	8	67.5	84	1	0.6	1.0 ~ 1.5	0.978	0.900	
60	62	95	44	22	1.1	0.6	37.6	75.2	4 300	6 200	234412B	234712B	86.1	83	11	4	8	72.5	89	1	0.6	1.1 ~ 1.7	1.04	0.957	
65	67	100	44	22	1.1	0.6	39.0	81.8	4 200	6 000	234413B	234713B	91	88	11	4	8	77.5	94	1	0.6	1.2 ~ 1.7	1.11	1.02	
70	73	110	48	24	1.1	0.6	47.5	103	3 800	5 500	234414B	234714B	100	97	12	4	8	85	104	1	0.6	1.7 ~ 2.5	1.52	1.40	
75	78	115	48	24	1.1	0.6	49.1	111	3 700	5 300	234415B	234715B	105	102	12	4	8	90	109	1	0.6	1.8 ~ 2.6	1.62	1.49	
80	83	125	54	27	1.1	0.6	57.6	132	3 400	4 800	234416B	234716B	113	110	13.5	4	8	96.5	119	1	0.6	2.4 ~ 3.6	2.19	2.03	
85	88	130	54	27	1.1	0.6	58.2	137	3 300	4 700	234417B	234717B	118	115	13.5	4	8	102	124	1	0.6	2.5 ~ 3.8	2.30	2.12	
90	93	140	60	30	1.5	1	67.4	160	3 000	4 300	234418B	234718B	127	123	15	4	8	109	133.5	1.5	1	3.3 ~ 4.9	3.03	2.79	
95	98	145	60	30	1.5	1	68.0	166	3 000	4 200	234419B	234719B	132	128	15	4	8	114	138.5	1.5	1	3.4 ~ 5.0	3.17	2.92	
100	—	140	48	24	1.1	0.6	52.2	135	2 800	3 800	239420B	—	131	126	12	4	8	114	134	1	0.6	3.1 ~ 4.6	2.08	—	
	103	150	60	30	1.5	1	68.7	172	2 900	4 100	234420B	234720B	137	133	15	4	8	119	143.5	1.5	1	3.4 ~ 5.1	3.33	3.06	
105	—	145	48	24	1.1	0.6	53.6	143	2 700	3 800	239421B	—	136	131	12	4	8	119	139	1	0.6	3.1 ~ 4.6	2.16	—	
	109	160	66	33	2	1	78.8	199	2 700	3 800	234421B	234721B	146	142	16.5	6	12	127	152	2	1	4.7 ~ 7.1	4.15	3.82	

[Note] 1) The dimension E_w is used as a reference for the ball set outside diameter.

Double direction angular contact thrust ball bearings

d 110 ~ (240) mm

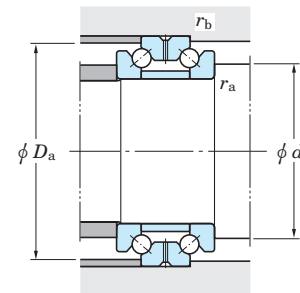
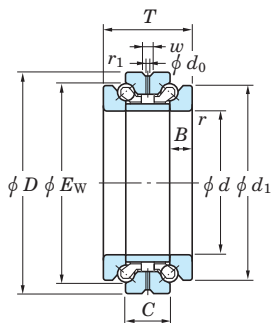

d	Boundary dimensions (mm)						Basic load ratings (kN)		Limiting speeds (min ⁻¹)		Bearing No.		Dimensions (mm)					Mounting dimensions (mm)				Amount of grease fill (cm ³ /row)		(Refer.) Mass (kg)	
	Small bore type	Large bore type	D	T	C	r min.	r ₁ min.	C _a	C _{0a}	Grease lub.	Oil lub.	Small bore type	Large bore type	E _w ¹⁾	d ₁	B	d ₀	w	d _a min.	D _a max.	r _a max.	r _b max.	Small bore type	Large bore type	Small bore type
110	—	150	48	24	1.1	0.6	53.9	148	2 700	3 700	239422B	—	141	136	12	4	8	124	144	1	0.6	3.0 ~ 4.5	2.25	—	
	114	170	72	36	2	1	95.9	235	2 500	3 500	234422B	234722B	155	150	18	6	12	133	162	2	1	5.9 ~ 8.8	5.38	4.95	
120	124	165	54	27	1.1	0.6	64.9	185	2 400	3 300	239424B	239724B	154.5	150	13.5	4	8	138	160	1	0.6	4.2 ~ 6.3	3.12	2.81	
	124	180	72	36	2	1	98.3	252	2 400	3 400	234424B	234724B	165	160	18	6	12	143	172	2	1	6.4 ~ 9.5	5.77	5.31	
130	134	180	60	30	1.5	1	75.0	217	2 100	3 000	239426B	239726B	168	163	15	4	8	150	172	1.5	1	5.8 ~ 8.7	4.19	3.77	
	135	200	84	42	2	1	139	340	2 100	3 000	234426B	234726B	182	177	21	6	12	155	192	2	1	9.3 ~ 13.9	8.63	7.94	
140	144	190	60	30	1.5	1	75.9	229	2 100	2 900	239428B	239728B	178	173	15	4	8	160	182	1.5	1	6.3 ~ 9.4	4.47	4.03	
	145	210	84	42	2	1	144	366	2 000	2 900	234428B	234728B	192	187	21	6	12	165	202	2	1	9.7 ~ 14.5	9.18	8.44	
150	155	210	72	36	2	1	107	312	1 800	2 500	239430B	239730B	196.5	190	18	4	8	174	200	2	1	9.6 ~ 14.4	7.01	6.31	
	155	225	90	45	2.1	1.1	147	394	1 900	2 700	234430B	234730B	206	200	22.5	6	14	178	215	2	1	12.0 ~ 17.9	11.3	10.4	
160	165	220	72	36	2	1	109	329	1 700	2 400	239432B	239732B	206.5	200	18	4	8	184	210	2	1	9.3 ~ 14.0	7.40	6.66	
	165	240	96	48	2.1	1.1	173	460	1 700	2 500	234432B	234732B	219	212	24	6	14	189	230	2	1	14.1 ~ 21.1	13.3	12.2	
170	175	230	72	36	2	1	111	346	1 700	2 300	239434B	239734B	216.5	210	18	4	8	194	220	2	1	10.8 ~ 16.2	7.79	7.01	
	176	260	108	54	2.1	1.1	203	547	1 600	2 200	234434B	234734B	236	230	27	6	14	203	250	2	1	18.6 ~ 27.8	18.1	16.6	
180	186	250	84	42	2	1	157	460	1 500	2 100	239436B	239736B	234	227	21	4	8	207	240	2	1	14.9 ~ 22.3	11.3	10.2	
	187	280	120	60	2.1	1.1	234	642	1 400	2 000	234436B	234736B	255	248	30	8	16	219	270	2	1	23.4 ~ 35.1	24.9	22.9	
190	196	260	84	42	2	1	157	474	1 400	2 000	239438B	239738B	242	237	21	4	8	217	250	2	1	15.7 ~ 23.5	11.9	10.7	
	197	290	120	60	2.1	1.1	237	665	1 400	1 900	234438B	234738B	265	258	30	8	16	229	280	2	1	24.7 ~ 37.1	25.0	23.0	
200	207	280	96	48	2.1	1.1	185	557	1 300	1 800	239440B	239740B	259	252	24	4	8	231	268	2	1	23.5 ~ 35.2	16.6	14.9	
	207	310	132	66	2.1	1.1	279	771	1 200	1 800	234440B	234740B	282	274	33	8	16	243	300	2	1	31.8 ~ 47.7	32.1	29.5	
220	227	300	96	48	2.1	1.1	191	606	1 200	1 700	239444B	239744B	280	272	24	6	12	251	288	2	1	24.7 ~ 37.0	18.0	16.2	
	228	340	144	72	3	1.1	334	939	1 100	1 600	234444B	234744B	310	304	36	12	22	267	330	2.5	1	43.0 ~ 64.4	42.0	38.6	
240	247	320	96	48	2.1	1.1	196	655	1 200	1 600	239448B	239748B	299	292	24	6	12	271	308	2	1	26.4 ~ 39.5	19.1	17.2	

[Note] 1) The dimension E_w is used as a reference for the ball set outside diameter.

Double direction angular contact thrust ball bearings

d (240) ~ 340 mm

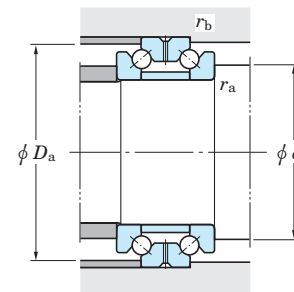
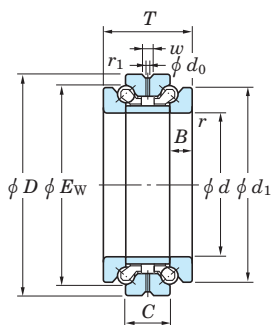

d	Boundary dimensions (mm)						Basic load ratings (kN)		Limiting speeds (min ⁻¹)		Bearing No.		Dimensions (mm)					Mounting dimensions (mm)				(Refer.) Mass (kg)		
	Small bore type	Large bore type	D	T	C	$r_{\min.}$	$r_{1\min.}$	C_a	C_{0a}	Grease lub.	Oil lub.	Small bore type	Large bore type	E_w ¹⁾	d_1	B	d_0	w	d_a min.	D_a max.	r_a max.	r_b max.	Amount of grease fill (cm ³ /row)	Small bore type
240	248	360	144	72	3	1.1	342	1 010	1 100	1 500	234448B	234748B	330	322	36	12	22	287	350	2.5	1	47.7 ~ 71.6	45.0	41.4
	269	400	164	82	4	1.5	406	1 270	920	1 300	234452B	234752B	364	354	41	12	22	315	388	3	1.5	67.0 ~ 101	65.8	60.5
260	269	360	120	60	2.1	1.1	261	869	950	1 300	239452B	239752B	335	328	30	6	12	299	344	2	1	43.7 ~ 65.5	33.5	30.2
	289	400	164	82	4	1.5	406	1 270	920	1 300	234452B	234752B	364	354	41	12	22	315	388	3	1.5	67.0 ~ 101	65.8	60.5
280	289	380	120	60	2.1	1.1	265	915	910	1 300	239456B	239756B	356	348	30	6	14	319	363	2	1	49.1 ~ 73.7	35.7	32.1
	289	420	164	82	4	1.5	417	1 360	880	1 300	234456B	234756B	384	374	41	12	22	335	408	3	1.5	73.5 ~ 110	69.8	64.2
300	310	420	144	72	3	1.1	352	1 150	770	1 100	239460B	239760B	391	384	36	6	14	349	398	2.5	1	71.5 ~ 107	56.1	50.5
	310	460	190	95	4	1.5	476	1 630	760	1 100	234460B	234760B	418	406	47.5	12	22	364	448	3	1.5	98.0 ~ 147	100	91.8
320	330	440	144	72	3	1.1	361	1 220	740	1 000	239464B	239764B	408	404	36	6	14	369	419	2.5	1	81.5 ~ 122	59.2	53.3
	330	480	190	95	4	1.5	479	1 680	730	1 000	234464B	234764B	438	426	47.5	12	22	384	468	3	1.5	108 ~ 162	106	97.5
340	—	460	144	72	3	1.1	368	1 290	710	980	239468B	—	428	424	36	8	16	389	438	2.5	1	84.5 ~ 127	63.1	—

[Note] 1) The dimension E_w is used as a reference for the ball set outside diameter.

Matched pair angular contact ball bearings

d 30 ~ 85 mm

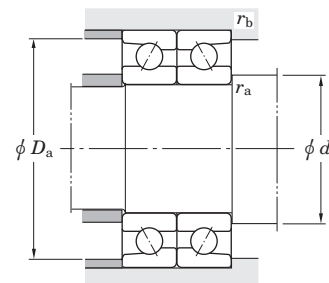
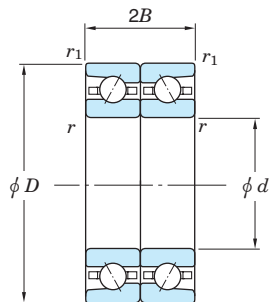

d	Boundary dimensions (mm)				Basic load ratings (kN)		Limiting speeds (min ⁻¹)		Bearing No. ¹⁾	Permissible axial loads (kN) (static)	Mounting dimensions (mm)				Envelope volume (cm ³ /row)	(Refer.) Mass (kg/row)
	D	$2B$	$r_{min.}$	$r_{1 min.}$	C_a	C_{0a}	Grease lub.	Oil lub.			d_a min.	D_a max.	r_a max.	r_b max.		
30	55	24	1	0.6	15.1	26.6	15 000	20 000	ACT006DB ACT006BDB	2.92	41	50	1	0.6	3.0	0.235
	55	24	1	0.6	18.1	30.5	13 000	18 000		9.86	41	50	1	0.6	3.0	0.235
35	62	25.5	1	0.6	15.8	30.2	13 000	17 000	ACT007DB ACT007BDB	3.25	46	57	1	0.6	4.2	0.312
	62	25.5	1	0.6	18.9	34.5	12 000	15 000		10.9	46	57	1	0.6	4.2	0.312
40	68	27	1	0.6	16.5	33.8	12 000	15 000	ACT008DB ACT008BDB	3.58	51	63	1	0.6	5.0	0.391
	68	27	1	0.6	19.6	37.7	11 000	14 000		12.1	51	63	1	0.6	5.0	0.391
45	75	28.5	1	0.6	18.4	38.6	11 000	14 000	ACT009DB ACT009BDB	3.84	56	70	1	0.6	5.7	0.536
	75	28.5	1	0.6	21.8	42.7	9 500	13 000		13.2	56	70	1	0.6	5.7	0.536
50	80	28.5	1	0.6	19.1	41.7	9 700	13 000	ACT010DB ACT010BDB	4.20	61	75	1	0.6	8.0	0.551
	80	28.5	1	0.6	22.7	46.3	8 800	12 000		14.5	61	75	1	0.6	8.0	0.551
55	90	33	1.1	0.6	23.7	52.8	8 700	11 000	ACT011DB ACT011BDB	5.63	68	84	1	0.6	12	0.831
	90	33	1.1	0.6	28.1	58.6	7 900	10 000		19.0	68	84	1	0.6	12	0.831
60	95	33	1.1	0.6	24.6	56.9	8 100	11 000	ACT012DB ACT012BDB	6.11	73	89	1	0.6	13	0.887
	95	33	1.1	0.6	29.1	63.1	7 400	9 700		20.6	73	89	1	0.6	13	0.887
65	100	33	1.1	0.6	25.4	60.9	7 600	10 000	ACT013DB ACT013BDB	6.59	78	94	1	0.6	14	0.943
	100	33	1.1	0.6	30.1	67.6	6 900	9 000		22.2	78	94	1	0.6	14	0.945
70	110	36	1.1	0.6	34.8	82.1	7 000	9 200	ACT014DB ACT014BDB	8.39	85	104	1	0.6	16	1.33
	110	36	1.1	0.6	41.3	91.1	6 300	8 300		28.8	85	104	1	0.6	16	1.33
75	115	36	1.1	0.6	35.3	84.9	6 600	8 700	ACT015DB ACT015BDB	8.74	90	109	1	0.6	20	1.35
	115	36	1.1	0.6	41.8	94.2	6 000	7 800		30.0	90	109	1	0.6	20	1.35
80	125	40.5	1.1	0.6	41.3	101	6 100	8 000	ACT016DB ACT016BDB	10.8	97	118	1	0.6	27	1.86
	125	40.5	1.1	0.6	49.1	112	5 500	7 200		36.6	97	118	1	0.6	27	1.86
85	130	40.5	1.1	0.6	41.9	105	5 800	7 600	ACT017DB ACT017BDB	11.2	102	123	1	0.6	29	1.94
	130	40.5	1.1	0.6	49.7	116	5 200	6 900		38.0	102	123	1	0.6	29	1.94

[Note] 1) B and no indication before matching code in bearing numbers represent nominal contact angle of 40° and 30° respectively.

Matched pair angular contact ball bearings

d 90 ~ 180 mm

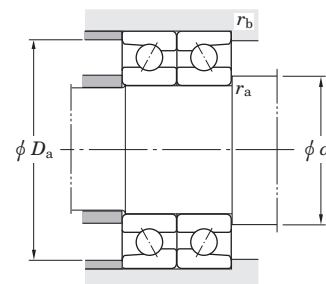
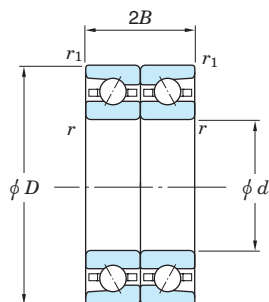

d	Boundary dimensions (mm)				Basic load ratings (kN)		Limiting speeds (min ⁻¹)		Bearing No. ¹⁾	Permissible axial loads (kN) (static)	Mounting dimensions (mm)				Envelope volume (cm ³ /row)	(Refer.) Mass (kg/row)
	D	$2B$	$r_{min.}$	$r_{1min.}$	C_a	C_{0a}	Grease lub.	Oil lub.			d_a min.	D_a max.	r_a max.	r_b max.		
90	140	45	1.5	1	55.0	138	5 400	7 100	ACT018DB ACT018BDB	14.2 48.7	109	132	1.5	1	39	2.55 2.55
	140	45	1.5	1	65.3	153	4 900	6 400								
95	145	45	1.5	1	55.8	143	5 200	6 800	ACT019DB ACT019BDB	14.8 50.6	114	137	1.5	1	40	2.62 2.62
	145	45	1.5	1	66.3	159	4 700	6 200								
100	150	45	1.5	1	56.6	148	5 000	6 500	ACT020DB ACT020BDB	15.3 52.5	119	143	1.5	1	42	2.77 2.77
	150	45	1.5	1	67.2	164	4 500	5 900								
105	160	49.5	2	1	64.4	170	4 700	6 100	ACT021DB ACT021BDB	18.2 63.2	125	151	2	1	50	3.61 3.61
	160	49.5	2	1	76.4	188	4 200	5 500								
110	170	54	2	1	72.4	193	4 400	5 800	ACT022DB ACT022BDB	19.6 71.3	132	160	2	1	64	4.52 4.52
	170	54	2	1	86.0	214	4 000	5 200								
120	180	54	2	1	74.6	206	4 100	5 400	ACT024DB ACT024BDB	21.0 76.4	142	170	2	1	69	4.83 4.83
	180	54	2	1	88.4	228	3 700	4 900								
130	200	63	2	1	94.2	253	3 700	4 800	ACT026DB ACT026BDB	25.9 93.0	156	188	2	1	106	7.21 7.21
	200	63	2	1	112	281	3 300	4 400								
140	210	63	2	1	102	290	3 400	4 500	ACT028DB ACT028BDB	29.9 107	166	198	2	1	110	7.69 7.65
	210	63	2	1	121	323	3 100	4 100								
150	225	67.5	2.1	1.1	120	344	3 200	4 200	ACT030DB ACT030BDB	34.7 125	178	213	2	1	138	9.39 9.39
	225	67.5	2.1	1.1	143	382	2 900	3 800								
160	240	72	2.1	1.1	130	377	3 000	3 900	ACT032DB ACT032BDB	39.1 139	190	227	2	1	167	11.4 11.4
	240	72	2.1	1.1	155	419	2 700	3 500								
170	260	81	2.1	1.1	153	449	2 700	3 600	ACT034DB ACT034BDB	45.7 163	204	245	2	1	221	15.7 15.7
	260	81	2.1	1.1	181	499	2 500	3 200								
180	280	90	2.1	1.1	173	510	2 500	3 300	ACT036DB ACT036BDB	54.0 183	216	264	2	1	313	22.2 22.2
	280	90	2.1	1.1	205	566	2 300	3 000								

[Note] 1) B and no indication before matching code in bearing numbers represent nominal contact angle of 40° and 30° respectively.

Matched pair angular contact ball bearings

d 190 ~ 320 mm

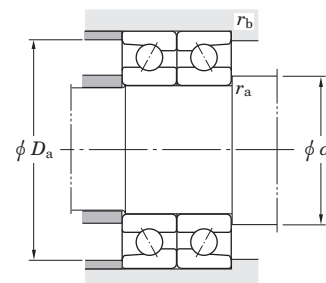
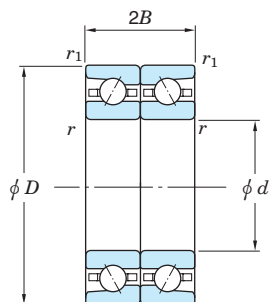

d	Boundary dimensions (mm)				Basic load ratings (kN)		Limiting speeds (min ⁻¹)		Bearing No. ¹⁾	Permissible axial loads (kN) (static)	Mounting dimensions (mm)				Envelope volume (cm ³ /row)	(Refer.) Mass (kg/row)
	D	2B	r _{min.}	r _{1 min.}	C _a	C _{0a}	Grease lub.	Oil lub.			d _{a min.}	D _{a max.}	r _{a max.}	r _{b max.}		
190	290	90	2.1	1.1	179	544	2 400	3 100	ACT038DB ACT038BDB	57.9	226	275	2	1	329	23.0
	290	90	2.1	1.1	213	604	2 200	2 800		196	226	275	2	1	329	23.0
200	310	99	2.1	1.1	215	633	2 200	2 900	ACT040DB ACT040BDB	64.8	240	293	2	1	421	29.5
	310	99	2.1	1.1	255	702	2 000	2 600		229	240	293	2	1	421	29.5
220	340	108	3	1.1	252	773	2 000	2 600	ACT044DB ACT044BDB	81.9	263	321	2.5	1	566	38.5
	340	108	3	1.1	299	858	1 800	2 400		278	263	321	2.5	1	566	38.5
240	360	108	3	1.1	260	823	1 800	2 400	ACT048DB ACT048BDB	87.9	283	343	2.5	1	605	41.1
	360	108	3	1.1	308	914	1 600	2 200		298	283	343	2.5	1	605	41.1
260	400	123	4	1.5	321	1 090	1 600	2 100	ACT052DB ACT052BDB	111	310	379	3	1.5	866	60.5
	400	123	4	1.5	381	1 210	1 500	1 900		393	310	379	3	1.5	866	60.5
280	420	123	4	1.5	332	1 160	1 500	2 000	ACT056DB ACT056BDB	119	330	401	3	1.5	915	64.1
	420	123	4	1.5	393	1 290	1 400	1 800		421	330	401	3	1.5	915	64.1
300	460	142.5	4	1.5	375	1 370	1 300	1 800	ACT060DB ACT060BDB	143	358	435	3	1.5	1 320	92.1
	460	142.5	4	1.5	444	1 530	1 200	1 600		501	358	435	3	1.5	1 320	92.1
320	480	142.5	4	1.5	378	1 420	1 200	1 600	ACT064DB ACT064BDB	148	378	457	3	1.5	1 400	96.9
	480	142.5	4	1.5	449	1 570	1 100	1 500		518	378	457	3	1.5	1 400	96.9

[Note] 1) B and no indication before matching code in bearing numbers represent nominal contact angle of 40° and 30° respectively.

Precision ball screw support bearings and bearing units

■ Support bearings were developed to support precision ball screw shafts. They have the same structure as angular contact thrust ball bearings with a contact angle of 60°.

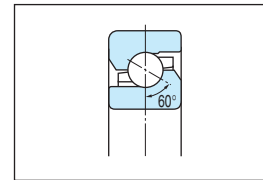

- Have a large axial load carrying capacity. Also able to carry a certain degree of radial load.
- Highly rigid in the axial direction.
- Starting torque is small.

Support bearings

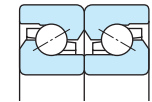

Bore diameter 17 – 60 mm

Support bearing units

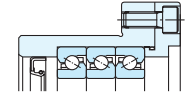

Bore diameter 17 – 40 mm

- Support bearing units consist of the bearings described above and a precisely processed housing. Units with a Koyo precision ball screw are also available.
- For details, refer to JTEKT separate catalog "Precision Ball and Roller Bearings for Machine Tools" (CAT. NO. B2005E).

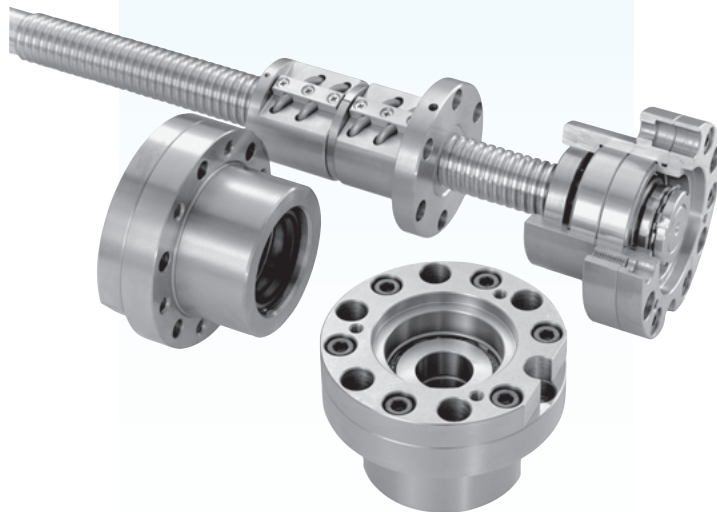

Table 1 Support bearing tolerance

(1) Inner ring Unit : μm

Nominal bore diameter d (mm)	Single plane mean bore diameter deviation		Single bore diameter deviation				Single inner ring width deviation		Inner ring width variation		Radial runout of assembled bearing inner ring		Perpendicularity of inner ring face with respect to the bore		Assembled bearing inner ring face runout with raceway				
	Δ_{dmp}		Δ_{ds}				Δ_{Bs}		V_{Bs}		K_{ia}		S_d		S_{ia}				
	class 5Z	class 4Z	class 5Z	class 4Z	class 5Z	class 4Z	class 5Z	class 4Z	class 5Z	class 4Z	class 5Z	class 4Z	class 5Z	class 4Z	class 5Z	class 4Z			
over	up to	upper	lower	upper	lower	upper	lower	upper	lower	max.	max.	max.	max.	max.	max.				
10	18	0	-5	0	-4	0	-5	0	-4	0	-80	5	2.5	4	2.5	7	3	5	3
18	30	0	-6	0	-5	0	-6	0	-5	0	-120	5	2.5	4	3	8	4	5	3
30	50	0	-8	0	-6	0	-8	0	-6	0	-120	5	3	5	4	8	4	6	3
50	80	0	-9	0	-7	0	-9	0	-7	0	-150	6	4	5	4	8	5	7	4

(2) Outer ring Unit : μm

Nominal outside diameter D (mm)	Single plane mean outside diameter deviation		Single outside diameter deviation				Single outer ring width deviation		Outer ring width variation		Radial runout of assembled bearing outer ring		Perpendicularity of outer ring outside surface with respect to the face		Assembled bearing outer ring face runout with raceway		
	Δ_{Dmp}		Δ_{Ds}				Δ_{Cs}		V_{Cs}		K_{ea}		S_D		S_{ea}		
	class 5Z	class 4Z	class 5Z	class 4Z	class 5Z	class 4Z	class 5Z	class 4Z	class 5Z	class 4Z	class 5Z	class 4Z	class 5Z	class 4Z	class 5Z	class 4Z	
over	up to	upper	lower	upper	lower	upper	lower	upper	lower	max.	max.	max.	max.	max.	max.		
30	50	0	-7	0	-6	0	-7	0	-6	Equivalent to Δ_{Bs} tolerances of a bearing of the same d	5	2.5	7	5	8	4	Equivalent to S_{ia} tolerances of a bearing of the same d
50	80	0	-9	0	-7	0	-9	0	-7		6	3	8	5	8	4	
80	120	0	-10	0	-8	0	-10	0	-8		8	4	10	6	9	5	

Precision ball screw support bearings

d 17 ~ 60 mm

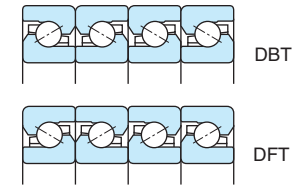
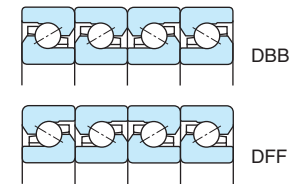
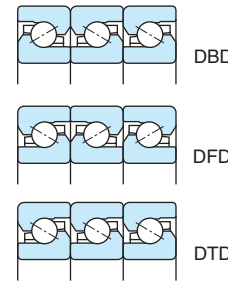
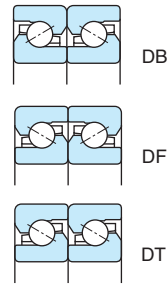
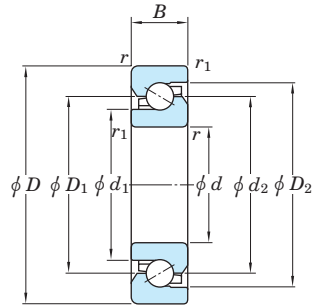

Boundary dimensions (mm)					Basic dynamic load rating ¹⁾ C_a (kN)	Max. axial loadings (kN)			Limiting speeds (min ⁻¹)		Bearing No. ²⁾	Envelope volume (cm ³ /row)	Dimensions (mm)				Standard preload (kN) Matching types			Starting torque (mN·m) Matching types			Axial rigidity (N/μm) Matching types			(Refer.) Mass (kg/row)
d	D	B	r min.	r_1 min.		Single-row	Double-row	Triple-row	Grease lub.	Oil lub.			d_1	d_2	D_1	D_2	Two bearings	Three bearings	Four bearings	Two bearings	Three bearings	Four bearings	Two bearings	Three bearings	Four bearings	
17	47	15	1	0.6	26.0	34.3	68.6	103	6 300	8 000	SAC1747B	3.7	25.5	33.7	33.5	41	2.15	2.92	4.30	140	180	280	695	1 030	1 390	0.13
20	47	15	1	0.6	26.0	34.3	68.6	103	6 300	8 000	SAC2047B	3.7	26.8	33.7	33.5	41	2.15	2.92	4.30	140	180	280	695	1 030	1 390	0.12
25	62	15	1	0.6	30.2	48.1	96.2	144	4 600	6 000	SAC2562B	4.9	38	46.2	46	53.5	3.04	4.13	6.08	200	260	400	970	1 440	1 940	0.24
30	62	15	1	0.6	30.2	48.1	96.2	144	4 600	6 000	SAC3062B	4.9	38	46.2	46	53.5	3.04	4.13	6.08	200	260	400	970	1 440	1 940	0.21
35	72	15	1	0.6	32.8	58.8	118	176	3 700	5 000	SAC3572B	6.2	48	56.3	55.9	63.5	3.73	5.07	7.46	240	320	480	1 180	1 760	2 360	0.29
40	72	15	1	0.6	32.8	58.8	118	176	3 700	4 800	SAC4072B	6.2	48	56.3	55.9	63.5	3.73	5.07	7.46	240	320	480	1 180	1 760	2 360	0.26
	90	20	1	0.6	65.4	122	244	366	3 100	4 000	SAC4090B	15	54.5	67.5	66.8	78.5	5.00	6.80	10.0	440	610	880	1 270	1 890	2 540	0.62
45	75	15	1	0.6	34.0	64.4	129	193	3 400	4 300	SAC4575B	6.9	54	61.7	61.5	69	3.89	5.29	7.78	250	330	500	1 270	1 890	2 540	0.25
	100	20	1	0.6	68.8	137	274	411	2 800	3 600	SAC45100B	16	61.5	74.2	74	85.5	5.95	8.09	11.9	540	730	1 080	1 450	2 150	2 900	0.79
50	100	20	1	0.6	70.3	144	288	432	2 700	3 400	SAC50100B	17	65.8	78.2	78	89.5	6.00	8.15	12.0	540	730	1 080	1 500	2 230	3 000	0.65
55	120	20	1	0.6	73.9	166	332	498	2 300	3 000	SAC55120B	20	79.5	92.2	92	103.6	7.08	9.62	14.2	640	860	1 280	1 740	2 590	3 480	1.15
60	120	20	1	0.6	73.9	166	332	498	2 300	3 000	SAC60120B	20	78.3	92.2	92	103.6	7.08	9.62	14.2	640	860	1 280	1 740	2 590	3 480	1.15

[Notes] 1) The basic dynamic load ratings of a single-row bearing are shown in this column. Those of matched pair and stack bearings are as shown below.

Dynamic equivalent load $P_a = XF_r + YF_a$

Number of rows which support axial loading	Basic dynamic load rating	Matching types (the arrow denotes the load direction.)
One	C_a	
Two	$C_a \times 1.625$	
Three	$C_a \times 2.16$	

Matching Types	Two bearings		Three bearings			Four bearings			
	DB DF	DT	DBD DFD	DTD	DBT DFT	DBB DFF	DBT DFT		
Number of rows which support axial loading	One	Two	One	Two	Three	One	Two	Three	
$\frac{F_a}{F_r} \leq 2.17$	X	1.9	—	1.43	2.33	—	1.17	2.33	2.53
	Y	0.54	—	0.77	0.35	—	0.89	0.35	0.26
$\frac{F_a}{F_r} > 2.17$	X	0.92							
	Y	1							

2) Matched bearing numbers consist of a single-row bearing number and a matching code such as DB or DF which is shown as a suffix.

Precision ball screw support bearing units

d 17 ~ 40 mm

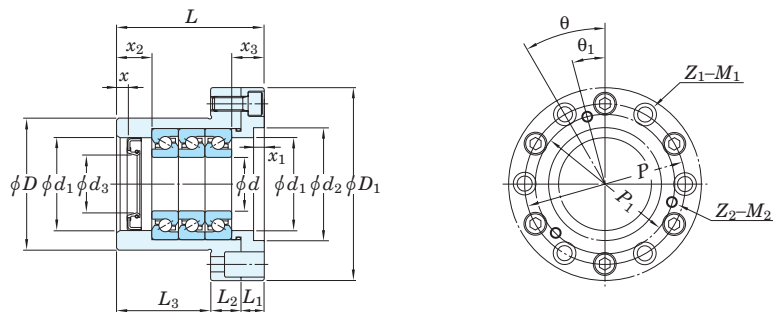

Dimensions (mm)													Applicable shaft dia. d_3 (mm)	Unit No. ¹⁾	Bearing qty.	Drilled-hole of housing			Tapped-hole for dust-cover			Standard preload (kN)	Starting torque (mN·m)	(Refer.) Mass (kg)
d	D	D_1	L	L_1	L_2	L_3	d_1	d_2	x	x_1	x_2	x_3				P (mm)	θ (°)	Z_1-M_1 Hole No.·thread	P_1 (mm)	θ_1 (°)	Z_2-M_2 Hole No.·thread			
17	60	90	65	15	15	35	38	47	6	6	15	20	28	BSU1747BDF	2	75	45	4-M6	75	22.5	4-M6	2.15	140	1.72
20	60	90	65	15	15	35	38	47	6	6	15	20	28	BSU2047BDF	2	75	45	4-M6	75	22.5	4-M6	2.15	140	1.70
25	74	108	68	13	17	38	52	63	6	6	20	18	32	BSU2562BDF	2	90	30	6-M8	78	15	3-M6	3.04	200	2.45
	74	108	83	13	17	53	52	63	6	6	20	18	32	BSU2562BDFD	3	90	30	6-M8	78	15	3-M6	4.13	260	2.85
30	74	108	68	13	17	38	52	63	6	6	20	18	40	BSU3062BDF	2	90	30	6-M8	78	15	3-M6	3.04	200	2.38
	74	108	83	13	17	53	52	63	6	6	20	18	40	BSU3062BDFD	3	90	30	6-M8	78	15	3-M6	4.13	260	2.74
35	84	118	68	13	17	38	60	73	6	6	20	18	45	BSU3572BDF	2	100	30	6-M8	88	15	3-M6	3.73	240	2.81
	84	118	83	13	17	53	60	73	6	6	20	18	45	BSU3572BDFD	3	100	30	6-M8	88	15	3-M6	5.07	320	3.28
	84	118	98	13	17	68	60	73	6	6	20	18	45	BSU3572BDFD	4	100	30	6-M8	88	15	3-M6	7.46	480	3.74
40	84	118	68	13	17	38	60	73	6	6	20	18	50	BSU4072BDF	2	100	30	6-M8	88	15	3-M6	3.73	240	2.77
	84	118	83	13	17	53	60	73	6	6	20	18	50	BSU4072BDFD	3	100	30	6-M8	88	15	3-M6	5.07	320	3.20
	84	118	98	13	17	68	60	73	6	6	20	18	50	BSU4072BDFD	4	100	30	6-M8	88	15	3-M6	7.46	480	3.64

[Note] 1) Diagrams show a unit mounted with triple-row matched bearing DFD. Specifications of each bearing are shown in the former pages. (BSU1747BDF → SAC1747BDF)

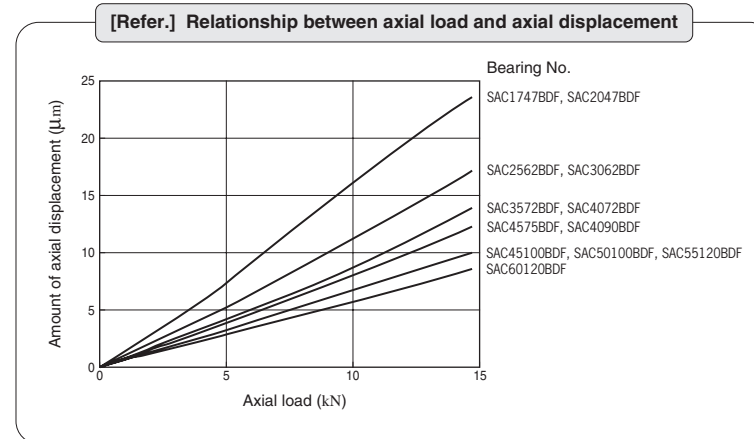

Full complement type cylindrical roller bearings for crane sheaves

Crane rope sheaves and running wheels which are operated at low or medium speed are generally equipped with full complement type cylindrical roller bearings because the operation of these machines involves heavy, impact loading.

These bearings are divided into shielded and open types. The shielded type is often used with the outer ring rotation.

■ Shielded type

- The shielded type was developed for use with rope sheaves. It is shielded, non-separable and pre-lubricated with grease.
- Bearings with locating snap rings around the outer ring can be positioned and fit to sheaves with ease.
- The bearing surface is coated with phosphate for rust prevention.

■ Open type

- Open type bearings are further divided into those used on the fixed side and those used on the free side. The former carry axial load in both directions. The relative position of the latter's inner ring and outer ring can be adjusted by moving them along the axis.
- Open type bearings are separable because the outer ring divided into two annular pieces in a plane perpendicular to its axis. Triple-row and four-row bearings are available along with double-row types.

Shielded type



Bore diameter **40 – 440 mm**

Open type



Bore diameter **50 – 440 mm**

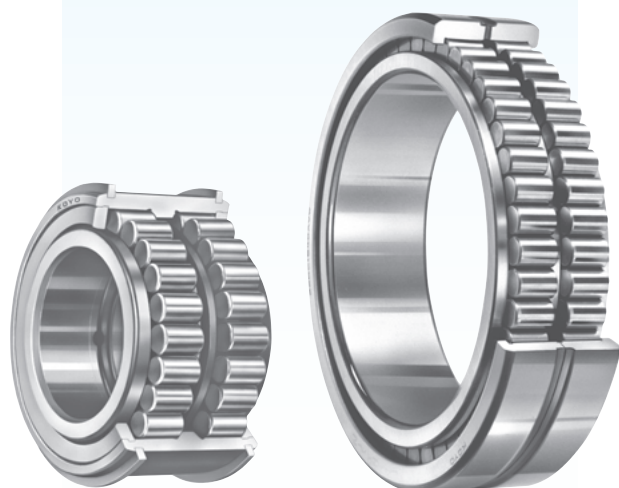

Tolerances	As specified in JIS B 1514-1, classes 0 and 6 (ref. Table 7-3 on pp. A 54-A 57).				
Recommended fits and radial internal clearance	<ul style="list-style-type: none"> • Recommended fits: refer to Table 9-4 on pp. A 85, 86. <ul style="list-style-type: none"> ■ Fits and clearance of full complement type cylindrical roller bearings for use with crane sheaves with the rotating outer ring load 				
			Shaft tolerance class	Housing bore tolerance class	Bearing radial internal clearance
	Rotating outer ring load	Light or fluctuating load Normal or heavy load Heavy load on thin section housing	g 6 or h 6	M 7 N 7 P 7	CN clearance C3 clearance C3 clearance
<ul style="list-style-type: none"> • Radial internal clearance : Refer to Table 10-8 (1) on p. A 100. As for the nominal bore dia. up to 140mm shielded type (DC5000 series), the corresponding CN clearance are shown below. <ul style="list-style-type: none"> ■ CN clearance of shielded type roller bearings for nominal diameter up to 140mm 					
Nominal bore dia. d (mm)		CN clearance (μm)			
over	up to	min.	max.		
30	40	35	70		
40	50	40	75		
50	65	45	90		
65	80	55	105		
80	100	65	115		
100	120	80	120		
120	140	90	130		

**Full complement type cylindrical roller bearings
for crane sheaves
shielded type**

d 40 ~ 150 mm

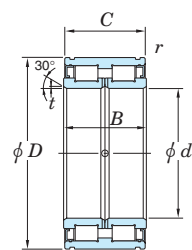

Design 1

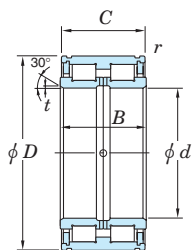

Design 2

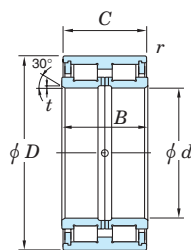

Design 3

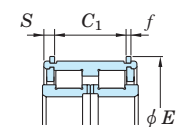

With locating snap rings

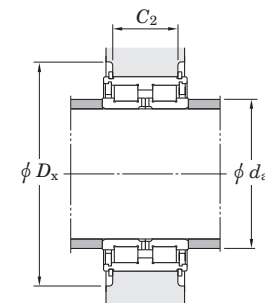

Boundary dimensions (mm)						Basic load ratings (kN)		Bearing No.		Design	Locating snap ring specifications (mm)				Mounting dimensions (mm)			(Refer.) Mass (kg)
<i>d</i>	<i>D</i>	<i>B</i>	<i>C</i>	<i>t</i>	<i>r</i> _{min.}	<i>C_r</i>	<i>C_{0r}</i>	Without locating snap rings	With locating snap rings		<i>C₁</i> ¹⁾	<i>S</i>	<i>E</i>	<i>f</i>	<i>d_a</i> _{min.}	<i>D_x</i> _{min.}	<i>C₂</i> ²⁾	
40	68	38	37	0.9	0.6	87.8	125	DC5008N	DC5008NR	1	28	4.5	71.8	2	46	80	28	0.55
45	75	40	39	0.9	0.6	95.1	144	DC5009N	DC5009NR	1	30	4.5	78.8	2	51	87	30	0.70
50	80	40	39	0.9	0.6	99.7	158	DC5010N	DC5010NR	1	30	4.5	83.8	2	56	92	30	0.75
55	90	46	45	1.2	0.6	118	193	DC5011N	DC5011NR	1	34	5.5	94.8	2.5	63	104	34	1.19
60	95	46	45	1.2	0.6	123	208	DC5012N	DC5012NR	1	34	5.5	99.8	2.5	68	109	34	1.27
65	100	46	45	1.2	0.6	128	224	DC5013N	DC5013NR	1	34	5.5	104.8	2.5	73	114	34	1.30
70	110	54	53	1.2	0.6	170	285	DC5014N	DC5014NR	1	42	5.5	114.5	2.5	78	124	42	1.94
75	115	54	53	1.2	0.6	178	307	DC5015N	DC5015NR	1	42	5.5	119.5	2.5	83	129	42	2.11
80	125	60	59	1.2	0.6	250	429	DC5016N	DC5016NR	1	48	5.5	129.5	2.5	88	146	48	2.65
85	130	60	59	1.2	0.6	255	446	DC5017N	DC5017NR	1	48	5.5	134.5	2.5	93	155	48	2.80
90	140	67	66	1.4	0.6	303	541	DC5018N	DC5018NR	1	54	6	145.4	2.5	100	165	54	3.70
95	145	67	66	1.4	0.6	310	562	DC5019N	DC5019NR	1	54	6	150.4	2.5	105	175	54	3.90
100	150	67	66	1.4	0.6	316	584	DC5020N	DC5020NR	1	54	6	155.4	2.5	110	180	54	4.05
110	170	80	79	1.7	1	382	697	DC5022N	DC5022NR	1	65	7	175.4	2.5	122	200	65	6.50
120	180	80	79	1.7	1	398	750	DC5024N	DC5024NR	1	65	7	188.4	3	132	210	65	6.95
130	200	95	94	1.7	1	534	1 000	DC5026N	DC5026NR	1	77	8.5	208.4	3	142	230	77	10.5
140	210	95	94	1.7	1	540	1 070	DC5028N	DC5028NR	1	77	8.5	218.4	3	152	245	77	11.0
150	225	100	99	2	1	682	1 400	DC5030N	DC5030NR	2	81	9	233	3	178.5	244	81	13.9

[Notes] 1) Dimensional tolerance of *C₁* is +0.4/0 when bore diameter is not more than 170mm, while +0.6/0 when bore diameter is not more than 170mm.

2) Dimensional tolerance of *C₂* is -0.1/-0.5 when bore diameter is not more than 170mm, while -0.1/-0.7 when bore diameter is not more than 170mm.

**Full complement type cylindrical roller bearings
for crane sheaves
shielded type**

d 160 ~ 440 mm

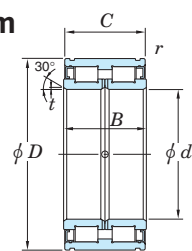

Design 1

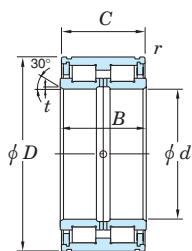

Design 2

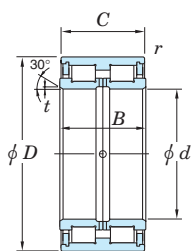

Design 3

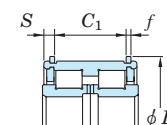

With locating snap rings

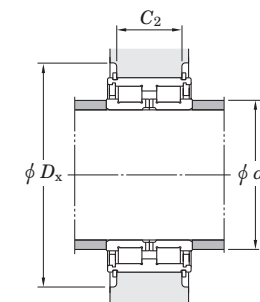

Boundary dimensions (mm)						Basic load ratings (kN)		Bearing No.		Design	Locating snap ring specifications (mm)				Mounting dimensions (mm)			(Refer.) Mass (kg)
<i>d</i>	<i>D</i>	<i>B</i>	<i>C</i>	<i>t</i>	<i>r</i> _{min.}	<i>C_r</i>	<i>C_{0r}</i>	Without locating snap rings	With locating snap rings		<i>C₁</i> ¹⁾	<i>S</i>	<i>E</i>	<i>f</i>	<i>d_a</i> _{min.}	<i>D_x</i> _{min.}	<i>C₂</i> ²⁾	
160	240	109	108	2	1.1	786	1 640	DC5032N	DC5032NR	2	89	9.5	248	3	190	259	89	17.2
170	260	122	121	2	1.1	977	2 020	DC5034N	DC5034NR	2	99	11	270	4	204	286	99	23.1
180	280	136	135	2	1.1	1 150	2 440	DC5036N	DC5036NR	2	110	12.5	290	4	217.5	306	110	30.8
190	290	136	135	2	1.1	1 180	2 530	DC5038N	DC5038NR	2	110	12.5	300	4	225	316	110	32.4
200	310	150	149	2	1.1	1 390	2 980	DC5040N	DC5040NR	2	120	14.5	320	4	240	336	120	41.7
220	340	160	159	2.5	1.1	1 620	3 590	DC5044N	DC5044NR	2	130	14.5	356	6	266.5	380	130	53.5
240	360	160	159	2.5	1.1	1 690	3 850	DC5048N	DC5048NR	2	130	14.5	376	6	284.5	400	130	57.3
260	400	190	189	3	1.5	2 230	4 980	DC5052N	DC5052NR	2	154	17.5	416	7	312.5	444	154	87.2
280	420	190	189	3	1.5	2 330	5 350	DC5056N	DC5056NR	2	154	17.5	436	7	334.5	464	154	93.0
300	460	218	216	3	1.5	2 860	6 610	DC5060	—	3	—	—	—	361	—	—	134	
320	480	218	216	3	1.5	2 950	6 930	DC5064	—	3	—	—	—	378.5	—	—	140	
340	520	243	241	3.5	2	3 590	8 420	DC5068	—	3	—	—	—	413	—	—	189	
360	540	243	241	3.5	2	3 660	8 720	DC5072	—	3	—	—	—	427	—	—	197	
380	560	243	241	3.5	2	3 730	9 020	DC5076	—	3	—	—	—	441	—	—	207	
400	600	272	270	3.5	2	4 510	11 000	DC5080	—	3	—	—	—	475.5	—	—	281	
420	620	272	270	3.5	2	4 650	11 400	DC5084	—	3	—	—	—	496	—	—	290	
440	650	280	278	4.5	3	4 940	12 200	DC5088	—	3	—	—	—	521	—	—	330	

[Notes] 1) Dimensional tolerance of *C₁* is +0.4/0 when bore diameter is not more than 170mm, while +0.6/0 when bore diameter is not more than 170mm.
2) Dimensional tolerance of *C₂* is -0.1/-0.5 when bore diameter is not more than 170mm, while -0.1/-0.7 when bore diameter is not more than 170mm.

Full complement type cylindrical roller bearings for crane sheaves

open type

d 50 ~ 200 mm

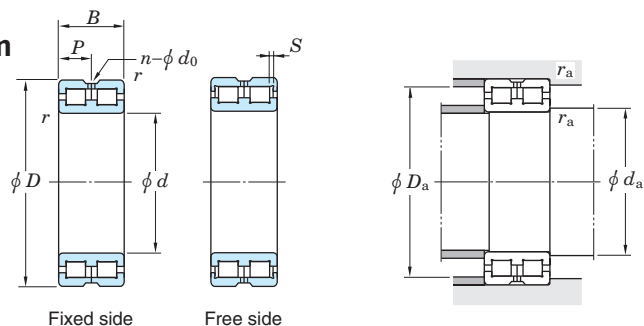

Boundary dimensions (mm)				$S^{1)}$ (mm)	Basic load ratings (kN)		Bearing No.		Lubrication hole (mm)			Mounting dimensions (mm)			Mass Fixed side (kg)
d	D	B	$r_{min.}$		C_r	C_{0r}	Fixed side	Free side	P	n qty	d_0	d_a min.	D_a max.	r_a max.	
50	72	22	0.6	1	49.1	82.9	DC4910AVW	DC4910VW	11	4	2	55	67	0.6	0.30
60	85	25	1	1	72.7	136	DC4912AVW	DC4912VW	12.5	4	2	66	79	1	0.46
70	100	30	1	1	105	193	DC4914AVW	DC4914VW	15	4	2	76	94	1	0.78
80	110	30	1	1	114	218	DC4916AVW	DC4916VW	15	4	2	86	104	1	0.88
90	125	35	1.1	1.5	150	301	DC4918AVW	DC4918VW	17.5	4	2.5	97	118	1	1.35
100	140	40	1.1	2	194	400	DC4920AVW	DC4920VW	20	4	2.5	107	133	1	1.95
110	150	40	1.1	2	202	431	DC4922AVW	DC4922VW	20	4	2.5	117	143	1	2.15
120	165	45	1.1	3	226	479	DC4924AVW	DC4924VW	22.5	4	3	127	158	1	2.95
130	180	50	1.5	4	276	560	DC4926AVW	DC4926VW	25	4	3	138.5	171.5	1.5	3.95
140	190	50	1.5	4	284	589	DC4928AVW	DC4928VW	25	4	3	148.5	181.5	1.5	4.20
150	190	40	1.1	2	234	575	DC4830AVW	DC4830VW	20	4	3	157	183	1	2.90
	210	60	2	4	406	842	DC4930AVW	DC4930VW	30	6	4	160	200	2	6.65
160	200	40	1.1	2	242	616	DC4832AVW	DC4832VW	20	4	3	167	193	1	3.05
	220	60	2	4	428	895	DC4932AVW	DC4932VW	30	6	4	170	210	2	7.00
170	215	45	1.1	3	269	655	DC4834AVW	DC4834VW	22.5	4	3	177	208	1	4.10
	230	60	2	4	440	944	DC4934AVW	DC4934VW	30	6	4	180	220	2	7.35
180	225	45	1.1	3	276	690	DC4836AVW	DC4836VW	22.5	4	4	187	218	1	4.30
	250	69	2	4	547	1 140	DC4936AVW	DC4936VW	34.5	6	4	190	240	2	10.7
190	240	50	1.5	4	327	782	DC4838AVW	DC4838VW	25	4	4	198.5	231.5	1.5	5.65
	260	69	2	4	555	1 200	DC4938AVW	DC4938VW	34.5	6	5	200	250	2	11.2
200	250	50	1.5	4	337	826	DC4840AVW	DC4840VW	25	4	4	208.5	241.5	1.5	5.90
	280	80	2.1	5	667	1 500	DC4940AVW	DC4940VW	40	6	6	212	268	2	15.7

[Note] 1) Effective movement of the bearing on the free side in an axial direction.

Full complement type cylindrical roller bearings
for crane sheaves

open type

d 220 ~ 440 mm

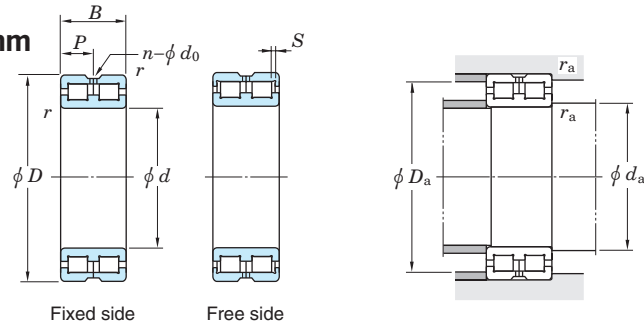

Boundary dimensions (mm)				S^1 (mm)	Basic load ratings (kN)		Bearing No.		Lubrication hole (mm)			Mounting dimensions (mm)			Mass Fixed side (kg)
d	D	B	$r_{min.}$		C_r	C_{0r}	Fixed side	Free side	P	n qty	d_0	d_a min.	D_a max.	r_a max.	
220	270	50	1.5	4	355	971	DC4844AVW	DC4844VW	25	6	4	228.5	261.5	1.5	6.40
	300	80	2.1	5	707	1 600	DC4944AVW	DC4944VW	40	6	6	232	288	2	17.1
240	300	60	2	4	509	1 330	DC4848AVW	DC4848VW	30	6	5	250	290	2	10.2
	320	80	2.1	5	735	1 720	DC4948AVW	DC4948VW	40	6	6	252	308	2	18.4
260	320	60	2	4	532	1 450	DC4852AVW	DC4852VW	30	6	5	270	310	2	11.0
	360	100	2.1	6	1 070	2 520	DC4952AVW	DC4952VW	50	8	6	272	348	2	32.0
280	350	69	2	4	663	1 720	DC4856AVW	DC4856VW	34.5	6	5	290	340	2	16.0
	380	100	2.1	6	1 130	2 700	DC4956AVW	DC4956VW	50	8	6	292	368	2	33.9
300	380	80	2.1	6	802	2 160	DC4860AVW	DC4860VW	40	8	6	312	368	2	23.0
	420	118	3	6	1 560	3 710	DC4960AVW	DC4960VW	59	8	8	314	406	2.5	53.0
320	400	80	2.1	6	832	2 310	DC4864AVW	DC4864VW	40	8	6	332	388	2	24.3
	440	118	3	6	1 620	3 940	DC4964AVW	DC4964VW	59	8	8	334	426	2.5	56.0
340	420	80	2.1	6	853	2 430	DC4868AVW	DC4868VW	40	8	6	352	408	2	25.6
	460	118	3	6	1 660	4 150	DC4968AVW	DC4968VW	59	8	8	354	446	2.5	59.0
360	440	80	2.1	6	880	2 580	DC4872AVW	DC4872VW	40	8	6	372	428	2	27.0
	480	118	3	6	1 700	4 390	DC4972AVW	DC4972VW	59	8	8	374	466	2.5	62.0
380	480	100	2.1	6	1 310	3 570	DC4876AVW	DC4876VW	50	8	6	392	468	2	45.3
	520	140	4	7	2 290	5 600	DC4976AVW	DC4976VW	70	8	8	398	502	3	92.3
400	540	140	4	7	2 380	5 990	DC4980AVW	DC4980VW	70	8	8	418	522	3	96.4
420	560	140	4	7	2 440	6 270	DC4984AVW	DC4984VW	70	8	8	438	542	3	101
440	600	160	4	7	2 970	7 390	DC4988AVW	DC4988VW	80	8	8	458	582	3	139

[Note] 1) Effective movement of the bearing on the free side in an axial direction.

Rolling mill roll neck bearings

Rolling mill roll neck four-row cylindrical roller bearings and tapered roller bearings are designed to achieve the maximum load rating capacity in a limited space.

- Four-row cylindrical roller bearings
 - Suitable for high-speed rotation. Thin section designs are also available.
 - The inner ring raceway surface and the roll can be finished simultaneously after the inner ring is mounted on the roll neck. This feature is useful in improving rolling mill accuracy.
- Four-row tapered roller bearings
 - Suitable for low- and medium-speed rotation. Available in both metric and inch series.
 - The internal clearance is preadjusted, facilitating mounting.
 - More sealed type four-row tapered roller bearings are being used currently.

Four-row cylindrical roller bearings

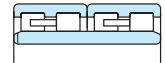

Cylindrical bore

Bore diameter **100 – 500 mm**

Four-row tapered roller bearings

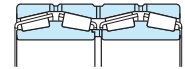

Open type

Bore diameter **65 – 500 mm**

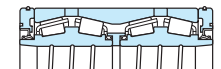

Sealed type

Bore diameter **75 – 800 mm**

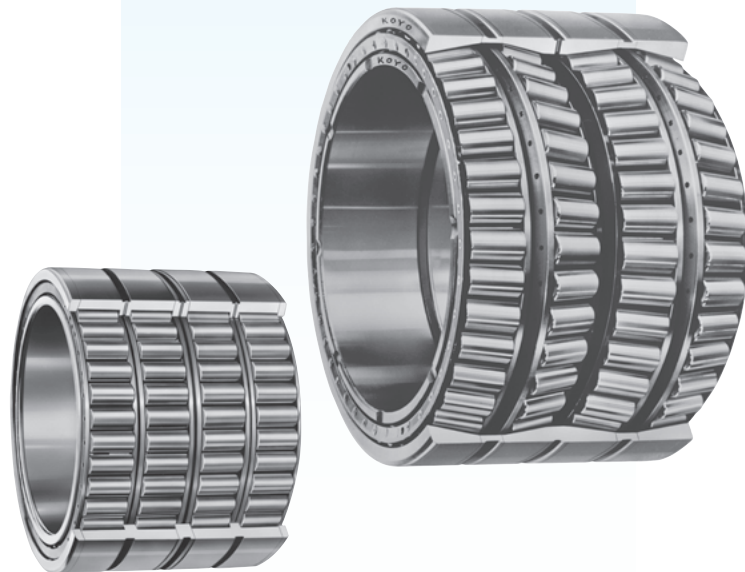

	Four-row cylindrical roller bearings	Four-row tapered roller bearings
Tolerances	As specified in JIS B 1514-1. (refer to Table 7-3 on pp. A 54-A 57.)	<ul style="list-style-type: none"> ● Metric series : as specified in BAS 1002. (refer to Table 7-6 on p. A 63.) ● Inch series : as specified in ABMA Section 19. (refer to Table 7-7 on pp. A 64, 65.) ● Special series (47T..., 4TR...) : Special allowances are applied to these series. For details, consult with JTEKT.
Recommended fits	Refer to Table 1.	<ul style="list-style-type: none"> ● Metric series : refer to Table 2. ● Inch series : refer to Table 3.
Internal clearance	Refer to Table 10-8 on pp. A 100, 101. (JTEKT should be consulted to determine the clearance according to application conditions.)	Refer to Table 10-10 on p. A 104.
Equivalent load	Dynamic equivalent radial load : $P_r = F_r$ Static equivalent radial load : $P_{0r} = F_r$	Dynamic equivalent radial load : $\left[\text{when } \frac{F_a}{F_r} \leq e \right] P_r = F_r + Y_2 F_a$ $\left[\text{when } \frac{F_a}{F_r} > e \right] P_r = 0.67 F_r + Y_3 F_a$ Static equivalent radial load : $P_{0r} = F_r + Y_0 F_a$

[Note] For axial load factor Y_2 , Y_3 and Y_0 , and the constant e , use values listed in the specification table.

Inner ring and roll neck (shaft)						Outer ring and chock (housing)					
Nominal bore diameter		Single plane mean bore diameter deviation		Roll neck diameter deviation		Nominal outside diameter		Single plane mean outside diameter deviation		Chock bore diameter deviation	
d (mm)		Δd_{mp}				D (mm)		ΔD_{mp}			
over	up to	upper	lower	upper	lower	over	up to	upper	lower	upper	lower
80	120	0	-20	+59	+37	120	150	0	-18	+40	0
120	180	0	-25	+68	+43 (p6)	150	180	0	-25	+40	0 (H7)
180	250	0	-30	+79	+50	180	250	0	-30	+46	0
250	280	0	-35	+126	+94	250	315	0	-35	+52	0 (H7)
280	315	0	-35	+130	+98 (r6)	315	400	0	-40	+75	+18 (G7)
315	355	0	-40	+144	+108	400	500	0	-45	+83	+20 (G7)
355	400	0	-40	+150	+114	500	630	0	-50	+92	+22 (G7)
400	450	0	-45	+166	+126 (r6)						
450	500	0	-45	+172	+132						
500	560	0	-50	+194	+150 (r6)	630	800	0	-75	+160	+80 (F7)
560	630	0	-50	+354	+310 (s6)						
630	710	0	-75	+390	+340 (s6)						
710	800	0	-75	+430	+380	800	1 000	0	-100	+176	+86 (F7)
800	900	0	-100	+486	+430 (s6)						
900	1 000	0	-100	+526	+470						
1 000	1 120	0	-125	+588	+520 (s6)	1 000	1 250	0	-125	+203	+98 (F7)
1 120	1 250	0	-125	+646	+580 (s6)						
						1 250	1 400	0	-160	+235	+110 (F7)
						1 400	1 600	0	-160	+345	+220 (E7)

[Note] The table above shows general values. JTEKT determines recommended fit on a case by case basis according to bearing materials and operating conditions to prevent the inner ring from creeping. Consult with JTEKT when referring to this table.

Double inner ring and roll neck (shaft)						Outer ring and chock (housing)					
Nominal bore diameter		Single plane mean bore diameter deviation		Roll neck diameter deviation		Nominal outside diameter		Single plane mean outside diameter deviation		Chock bore diameter deviation	
d (mm)		Δd_{mp}				D (mm)		ΔD_{mp}			
over	up to	upper	lower	upper	lower	over	up to	upper	lower	upper	lower
80	120	0	-20	-120	-150	120	150	0	-20	+57	+25
120	180	0	-25	-150	-175	150	180	0	-25	+100	+50
180	250	0	-30	-175	-200	180	250	0	-30	+120	+50
250	315	0	-35	-210	-250	250	315	0	-35	+115	+50
315	400	0	-40	-240	-300	315	400	0	-40	+110	+50
400	500	0	-45	-245	-300	400	500	0	-45	+105	+50
500	630	0	-50	-250	-300	500	630	0	-50	+100	+50
630	800	0	-75	-325	-400	630	800	0	-75	+150	+75
800	1 000	0	-100	-350	-425	800	1 000	0	-100	+150	+75
1 000	1 250	0	-125	-425	-500	1 000	1 250	0	-125	+175	+100
1 250	1 600	0	-160	-510	-600	1 250	1 600	0	-160	+215	+125
						1 600	2 000	0	-200	+250	+150

Double inner ring and roll neck (shaft)						Outer ring and chock (housing)					
Nominal bore diameter		Single plane mean bore diameter deviation		Roll neck diameter deviation		Nominal outside diameter		Single plane mean outside diameter deviation		Chock bore diameter deviation	
d (mm)(1/25.4)		Δd_{mp}				D (mm)(1/25.4)		ΔD_{mp}			
over	up to	upper	lower	upper	lower	over	up to	upper	lower	upper	lower
76.2	101.6	+25	0	-75	-100	-	304.8	+25	0	+75	+50
(3.0)	(4.0)						(12.0)				
101.6	127.0	+25	0	-100	-125	304.8	609.6	+51	0	+150	+100
(4.0)	(5.0)					(12.0)	(24.0)				
127.0	152.4	+25	0	-125	-150	609.6	914.4	+76	0	+225	+150
(5.0)	(6.0)					(24.0)	(36.0)				
152.4	203.2	+25	0	-150	-175	914.4	1 219.2	+102	0	+300	+200
(6.0)	(8.0)					(36.0)	(48.0)				
203.2	304.8	+25	0	-175	-200	1 219.2	1 524.0	+127	0	+375	+250
(8.0)	(12.0)					(48.0)	(60.0)				
304.8	609.6	+51	0	-200	-250	1 524.0	-	+127	0	+450	+300
(12.0)	(24.0)					(60.0)					
609.6	914.4	+76	0	-250	-325						
(24.0)	(36.0)										
914.4	1 219.2	+102	0	-300	-400						
(36.0)	(48.0)										
1 219.2	-	+127	0	-375	-475						
(48.0)											

Four-row cylindrical roller bearings

d 100 ~ (160) mm

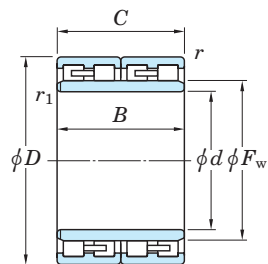

Design 1-1

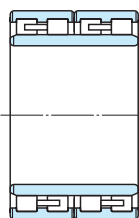

Design 1-2

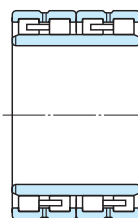

Design 1-3

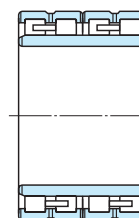

Design 1-4

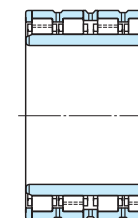

Design 1-6P

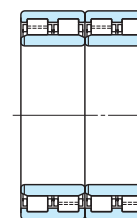

Design 2-1P

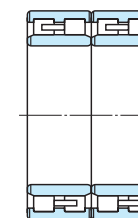

Design 2-2

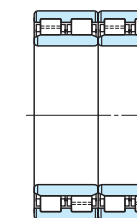

Design 2-2P

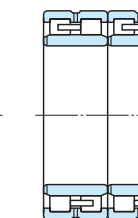

Design 2-3

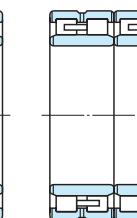

Design 2-4

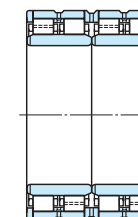

Design 2-5P

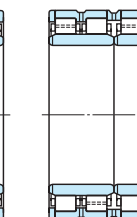

Design 2-6P

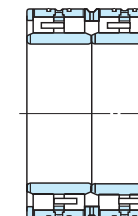

Design 3-1

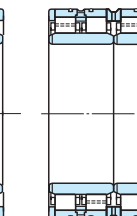

Design 3-1P

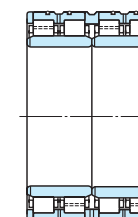

Design 3-2P

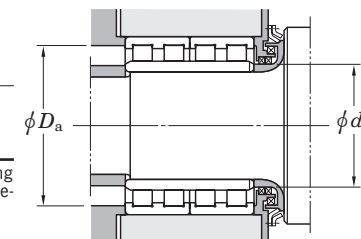

Boundary dimensions (mm)					Basic load ratings (kN)				Bearing No.	Design ¹⁾	Mounting dimensions (mm)					(Refer.) Mass (kg)													
d	D	B	C	F _w	C _r	C _{0r}	r _{min.}	r _{1 min.}			d _{a min.}	D _{a max.}	r _{a 2) max.}	r _{b 2) max.}															
100	140	120	120	110	485	945	1.1	1.1	20FC14120	2-2	107	133	131	1	1	5.6													
110	170	90	90	127	428	692	2	2	22FC1790	1-2	120	160	155	2	2	7.4													
		180	120	120													128	2	2	636	971	22FC18120	2-2	119	170	164	2	1.5	12
115	165	90	90	132.5	398	751	1.1	1.1	23FC1690	1-1	122	158	154	1	1	6.5													
120	165	87	87	134.5	374	745	1.1	1.1	24FC1787	1-2	127	158	154	1	1	5.6													
		180	105	105													135	2	1.1	487	796	4CR120	1-2	127	170	165	2	1	9.3
127	174.65	150.812	150.812	139.5	630	1 300	1.1	1.1	25FC17150	2-2	134	167	163	1	1	10.5													
		203.2	127	127													147	2	2	740	1 180	25FC20127	1-3	137	193	185	2	2	15.4
130	200	104	104	150	566	953	2	2	26FC20104	1-2	140	190	182	2	2	11.8													
		200	125	125													149	2	2	752	1 310	26FC20125	1-2	140	190	183	2	2	14.4
140	190	119	119	154	565	1 160	1.5	1.5	28FC19119W	1-3	149	181	178	1.5	1.5	9.6													
		210	116	116													158	2	2	675	1 120	28FC21116	1-2	150	200	194	2	2	13.5
145	210	155	155	166	845	1 710	1.1	1.1	29FC21155	1-2	152	203	196	1	1	17.8													
		225	156	156													169	2	2	912	1 680	313924	1-2	155	215	205	2	2	22.9
150	200	120	120	162	672	1 400	2	2	30FC20120	1-2	160	190	188	2	2	10.1													
		210	120	120													168.5	2	2	686	1 380	30FC21120	2-2	160	200	196	2	2	12.8
		210	150	150													165	2	2	872	1 780	30FC21150	1-2	160	200	195	2	2	15.9
		220	150	150													170	2	2	887	1 760	30FC22150	1-2	160	210	202	2	2	19.2
		220	150	150													168	2	2	889	1 760	30FC22150A	1-2	160	210	200	2	2	19.5
		230	156	156													174	2	2	961	1 810	313891-1	1-2	160	220	210	2	2	23.8
160	220	180	180	177	964	2 170	2	2	32FC22180	1-2	170	210	205	2	2	20.5													
		230	130	130													180	2.1	2.1	867	1 740	314190	1-2	172	218	212	2	2	17.7

[Notes] 1) Design numbers indicate the following meanings with P..... pin type cages without P..... machined cages

	Outer ring with rib	Outer ring with loose rib
One inner ring	1-1, 1-2, 1-3, 1-4	1-6P
Two inner rings	2-1P, 2-2, 2-2P, 2-3, 2-4	2-5P, 2-6P
Extended inner ring		3-1, 3-1P, 3-2P

2) r_a indicates housing chamfer dimension corresponding to outer ring chamfer dimension r. r_b indicates the shaft chamfer dimension corresponding to inner ring chamfer dimension r₁.

Four-row cylindrical roller bearings

d (160) ~ 190 mm

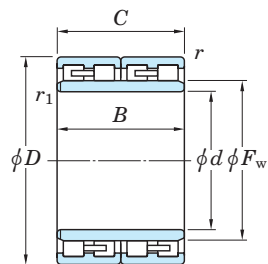

Design 1-1

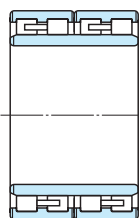

Design 1-2

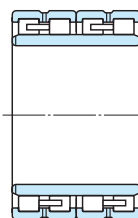

Design 1-3

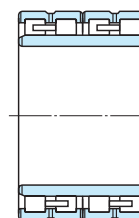

Design 1-4

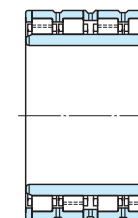

Design 1-6P

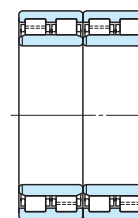

Design 2-1P

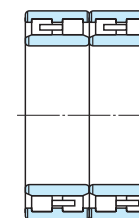

Design 2-2

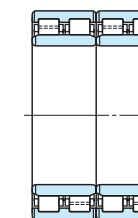

Design 2-2P

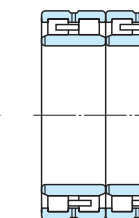

Design 2-3

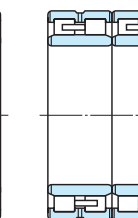

Design 2-4

Boundary dimensions (mm)							Basic load ratings (kN)		Bearing No.	Design ¹⁾	Mounting dimensions (mm)					(Refer.) Mass (kg)
d	D	B	C	F _w	r min.	r ₁ min.	C _r	C _{0r}			d _a min.	D _a max.	r _a ²⁾ max.	r _b ²⁾ max.		
160	230	168	168	182	1.1	1.1	1 040	2 210	32FC23170	1-2	167	223	214	1	1	22.8
	230	168	168	180	2	2	1 040	2 200	32FC23170A	1-2	170	220	212	2	2	23.1
	230	168	168	179	2	2	1 110	2 210	32FC23170B	1-4	170	220	215	2	2	22.6
	230	180	180	177	2	2	1 140	2 270	32FC23180A	1-2	170	220	213	2	2	24.1
	240	120	120	183	2.1	2.1	663	1 140	32FC24120W	1-3	172	228	219	2	2	18.5
	240	170	170	183	2.1	2.1	1 180	2 220	32FC24170	1-2	172	228	223	2	2	26.8
170	230	120	120	187	2	2	782	1 680	34FC23120	1-2	180	220	215	2	2	14.4
	240	156	156	190	2	2	972	2 050	34FC24156A	1-2	180	230	222	2	2	22.4
	240	156	156	189	2	2	1 060	2 100	34FC24156B	1-2	180	230	225	2	2	21.8
	240	190	190	187	1.5	1.5	1 260	2 620	34FC24190	1-2	179	231	223	1.5	1.5	26.9
	250	168	168	192	2.1	2.1	1 170	2 230	34FC25168	1-2	182	238	232	2	2	27.6
	250	170	170	192	2.1	2.1	1 170	2 230	34FC25170	1-2	182	238	232	2	2	27.8
	260	150	150	195	2.1	2.1	1 100	2 000	34FC26150	1-2	182	248	237	2	2	28.8
178	258.75	150	150	199	1.5	1.5	1 090	2 070	36FC26150	1-2	187	250	239	1.5	1.5	25.8
180	250	156	156	200	2	2	1 020	2 130	36FC25156A	1-2	190	240	234	2	2	23.3
	260	168	168	202	2.1	2.1	1 150	2 390	313812W	1-4	192	248	238	2	2	29.7
	260	168	168	202	2.1	2.1	1 230	2 420	36FC26168	1-2	192	248	242	2	2	29.3
	265	180	180	203	2	2	1 300	2 600	36FC27180	1-2	190	255	243	2	2	33.6
190	260	168	168	212	2.1	2.1	1 140	2 600	38FC26168-1	1-2	202	248	244	2	2	26.5
	270	170	170	212	2	2	1 140	2 310	38FC27170	1-2	200	260	250	2	2	30.8
	270	170	170	213	2	2	1 140	2 310	38FC27170A	1-2	200	260	251	2	2	31.0
	270	200	200	212	2	2	1 460	3 080	314199	1-2	200	260	252	2	2	36.1
	280	200	200	214	2.1	2.1	1 550	3 100	38FC28200	1-2	202	268	258	2	2	42
	290	190	190	215	2.1	2.1	1 550	2 860	38FC29190	1-2	202	278	265	2	2	44.9

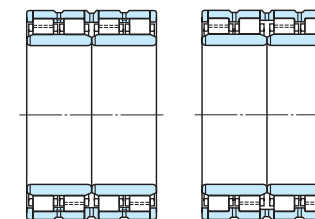

Design 2-5P

Design 2-6P

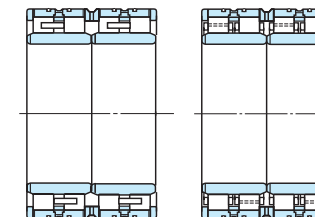

Design 3-1

Design 3-1P

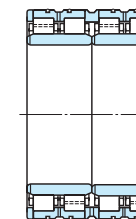

Design 3-2P

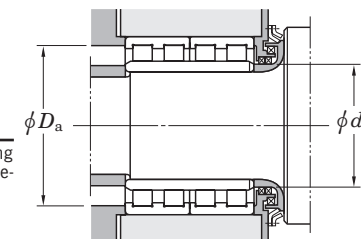

[Notes] 1) Design numbers indicate the following meanings
 with P pin type cages
 without P machined cages

	Outer ring with rib	Outer ring with loose rib
One inner ring	1-1, 1-2, 1-3, 1-4	1-6P
Two inner rings	2-1P, 2-2, 2-2P, 2-3, 2-4	2-5P, 2-6P
Extended inner ring		3-1, 3-1P, 3-2P

2) r_a indicates housing chamfer dimension corresponding to outer ring chamfer dimension r. r_b indicates the shaft chamfer dimension corresponding to inner ring chamfer dimension r₁.

Four-row cylindrical roller bearings

d 195 ~ 230 mm

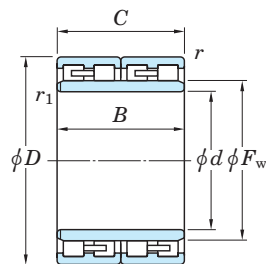

Design 1-1

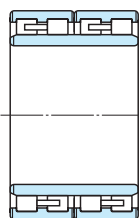

Design 1-2

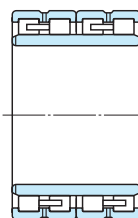

Design 1-3

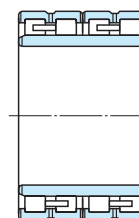

Design 1-4

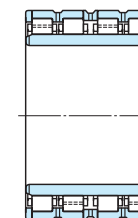

Design 1-6P

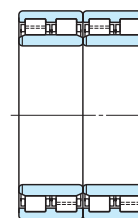

Design 2-1P

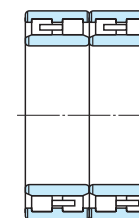

Design 2-2

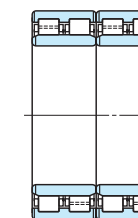

Design 2-2P

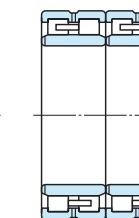

Design 2-3

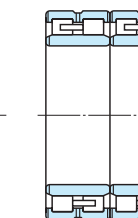

Design 2-4

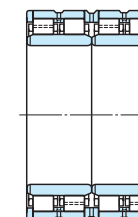

Design 2-5P

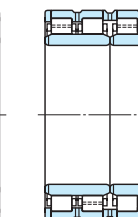

Design 2-6P

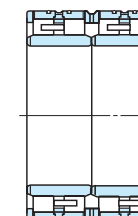

Design 3-1

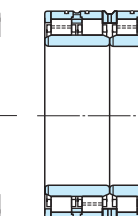

Design 3-1P

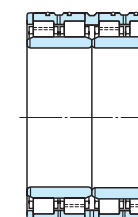

Design 3-2P

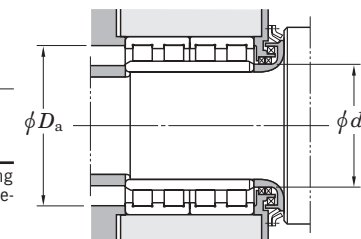

Boundary dimensions (mm)							Basic load ratings (kN)		Bearing No.	Design ¹⁾	Mounting dimensions (mm)				(Refer.) Mass (kg)	
d	D	B	C	F_w	$r_{min.}$	$r_{1 min.}$	C_r	C_{0r}			d_a min.	D_a max.	r_a ²⁾ min.	r_b ²⁾ max.		
195	300	226	226	220	2.1	2.1	1 960	3 690	39FC30226	1-2	207	288	274	2	2	57.9
200	270	170	170	222	2	2.1	1 190	2 780	314553	1-2	212	260	254	2	2	28.0
	280	152	152	222	2.1	2.1	1 100	2 150	40FC28152BW	1-3	212	268	262	2	2	28.0
	280	170	170	222	2.1	2.1	1 280	2 620	40FC28170	1-2	212	268	262	2	2	31.7
	280	188	188	222	2.1	2.1	1 350	2 810	40FC28188	1-2	212	268	262	2	2	35.0
	280	190	190	223	3	3	1 460	3 100	40FC28190A	1-2	214	266	263	2.5	2.5	36.0
	280	200	200	222	2	2	1 450	3 090	313893-1	1-2	210	270	262	2	2	37.7
	280	200	200	224	2.1	2.1	1 450	3 330	40FC28200	1-2	212	268	260	2	2	38.7
	290	192	192	226	2.1	2.1	1 460	3 030	313811	1-2	212	278	268	2	2	42.0
	310	160	160	232	2.1	2.1	1 260	2 240	40FC31160	1-1	212	298	282	2	2	44.6
310	206	206	227	2.1	2.1	1 790	3 240	40FC31206	1-2	212	298	283	2	2	56.6	
206	299.97	170	170	229	2	2	1 470	2 780	41FC30170	1-2	216	289	277	2	2	39.2
	210	290	192	192	236	2.1	2.1	1 460	3 270	42FC29192	1-2	222	278	274	2	2
210	300	210	210	234	2.1	2.1	1 660	3 490	42FC30210	1-2	222	288	278	2	2	47.3
	220	300	150	150	240	2.1	2.1	1 210	2 500	44FC30150W	1-3	232	288	280	2	2
310		192	192	247	2.1	2.1	1 520	3 270	313837-1	1-2	232	298	289	2	2	45.5
310		192	192	246	2	2	1 630	3 420	313837A	1-2	230	300	291	2	2	44.9
310		192	192	245	3	2.1	1 450	2 980	44FC31192W	1-3	232	296	289	2.5	2	43.9
310		225	225	244	2.1	2.1	1 880	4 160	44FC31225A	1-2	232	298	288	2	2	53.5
320		210	210	246	2.1	2.1	1 760	3 490	44FC32210	1-2	232	308	296	2	2	55.4
320		210	210	248	2.1	2.1	1 810	3 740	44FC32210-1	1-4	232	308	296	2	2	56.7
340		180	180	256	3	3	1 500	2 750	44FC34180A	1-4	234	326	310	2.5	2.5	59.0
230		330	206	206	260	2.1	2.1	1 880	3 980	313824A	1-2	242	318	308	2	2
	340	260	260	261	3	3	2 310	4 900	46FC34260	1-2	244	326	313	2.5	2.5	81.2

[Notes] 1) Design numbers indicate the following meanings
 with P pin type cages
 without P machined cages

	Outer ring with rib	Outer ring with loose rib
One inner ring	1-1, 1-2, 1-3, 1-4	1-6P
Two inner rings	2-1P, 2-2, 2-2P, 2-3, 2-4	2-5P, 2-6P
Extended inner ring		3-1, 3-1P, 3-2P

2) r_a indicates housing chamfer dimension corresponding to outer ring chamfer dimension r . r_b indicates the shaft chamfer dimension corresponding to inner ring chamfer dimension r_1 .

Four-row cylindrical roller bearings

d 237 ~ (280) mm

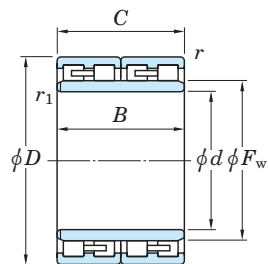

Design 1-1

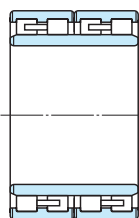

Design 1-2

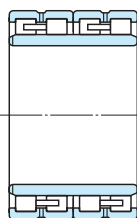

Design 1-3

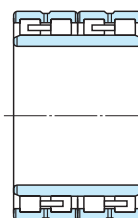

Design 1-4

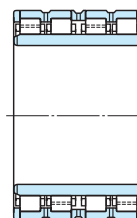

Design 1-6P

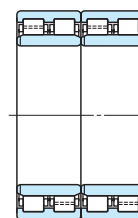

Design 2-1P

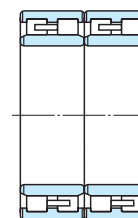

Design 2-2

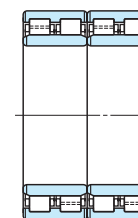

Design 2-2P

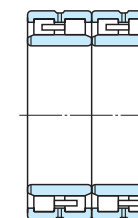

Design 2-3

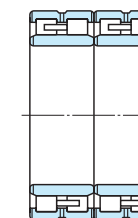

Design 2-4

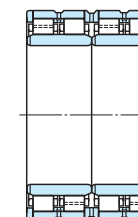

Design 2-5P

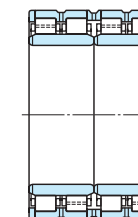

Design 2-6P

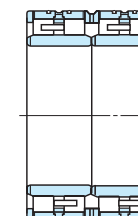

Design 3-1

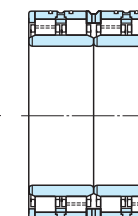

Design 3-1P

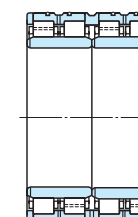

Design 3-2P

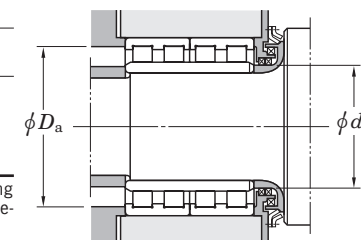

Boundary dimensions (mm)							Basic load ratings (kN)		Bearing No.	Design ¹⁾	Mounting dimensions (mm)				(Refer.) Mass (kg)	
d	D	B	C	F _w	r min.	r ₁ min.	C _r	C _{0r}			d _a min.	D _a max.	r _a ²⁾ min.	r _b ²⁾ max.		
237	339.67	200	200	264	2	2	1 840	3 780	47FC34200	1-2	247	329	314	2	2	58.0
240	330	220	220	270	3	3	1 780	4 250	312943/1YD	1-4	254	316	310	2.5	2.5	55.5
	330	220	220	264	2.1	2.1	1 830	4 120	48FC33220	1-2	252	318	308	2	2	54.3
	330	220	220	268	3	3	1 770	4 070	48FC33220BW	1-4	254	316	310	2.5	2.5	55.5
	330	250	250	263	2.1	2.1	2 160	4 910	48FC33250W	1-3	252	318	309	2	2	63.7
	340	200	200	266	3	3	1 880	3 780	48FC34200	1-2	254	326	318	2.5	2.5	56.3
	340	220	220	268	3	3	2 000	4 240	48FC34220	1-2	254	326	318	2.5	2.5	63.4
250	350	220	220	278	3	3	1 930	4 200	50FC35220	1-2	264	336	326	2.5	2.5	64.6
260	355	260	260	286	2.1	2.1	2 290	5 440	52FC35260	2-2	272	343	332	2	2	75.0
	360	192	192	287	2.1	2.1	1 750	3 740	52FC36192W	1-3	272	348	335	2	2	59.8
	360	200	200	287	2.1	2.1	1 880	4 110	52FC36200	1-2	272	348	335	2	2	62.0
	360	230	230	292.5	2.1	2.1	2 140	4 900	52FC36230CW	1-4	272	348	340	2	2	69.7
	360	230	230	292	2.1	2.1	2 020	4 790	52FC36230D	1-2	272	348	336	2	2	72.6
	360	260	260	287	2.1	2.1	2 300	5 320	52FC36260	2-2	272	348	335	2	2	80.0
	368	268	268	288	2.1	2.1	2 740	5 990	52FC37268W	1-4	272	356	344	2	2	89.9
	370	220	220	292	3	3	2 000	4 330	313823	1-2	274	356	342	2.5	2.5	76.0
	370	220	220	290	3	3	2 180	4 480	313823A	1-2	274	356	346	2.5	2.5	75.0
	370	260	260	290	2.1	2.1	2 640	5 740	52FC37260	1-2	272	358	346	2	2	88.5
265	370	234	234	292	1.5	1.5	2 290	4 910	53FC37234A	1-2	274	361	346	1.5	1.5	76.3
	370	234	234	300	1.5	1.5	2 270	5 290	53FC37234B	2-2	274	361	348	1.5	1.5	78.5
270	380	230	230	298	2.1	2.1	2 330	4 910	54FC38230	1-2	282	368	354	2	2	80.0
280	380	170	170	306	2.1	2.1	1 710	3 590	56FC38170W	1-3	292	368	356	2	2	55.0
	390	220	220	312	3	3	2 070	4 640	313822	1-2	294	376	362	2.5	2.5	81.8
	390	220	220	308	3	3	2 180	4 670	313822A	1-2	294	376	362	2.5	2.5	79.7

[Notes] 1) Design numbers indicate the following meanings
 with P pin type cages
 without P machined cages

	Outer ring with rib	Outer ring with loose rib
One inner ring	1-1, 1-2, 1-3, 1-4	1-6P
Two inner rings	2-1P, 2-2, 2-2P, 2-3, 2-4	2-5P, 2-6P
Extended inner ring		3-1, 3-1P, 3-2P

2) r_a indicates housing chamfer dimension corresponding to outer ring chamfer dimension r. r_b indicates the shaft chamfer dimension corresponding to inner ring chamfer dimension r₁.

Four-row cylindrical roller bearings

d (280) ~ (320) mm

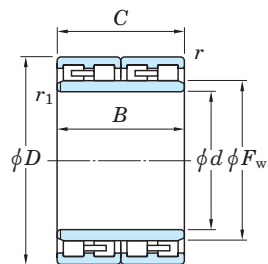

Design 1-1

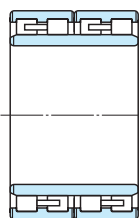

Design 1-2

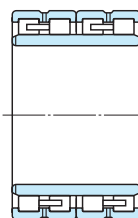

Design 1-3

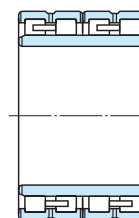

Design 1-4

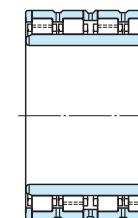

Design 1-6P

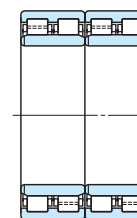

Design 2-1P

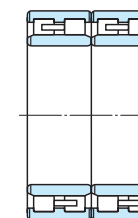

Design 2-2

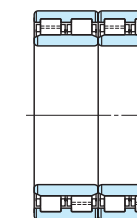

Design 2-2P

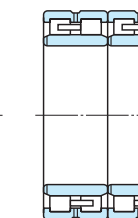

Design 2-3

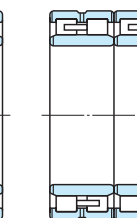

Design 2-4

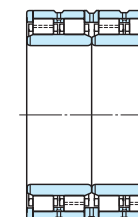

Design 2-5P

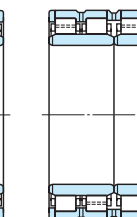

Design 2-6P

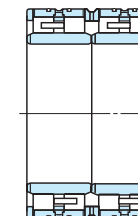

Design 3-1

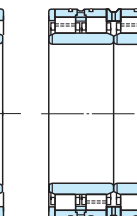

Design 3-1P

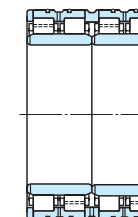

Design 3-2P

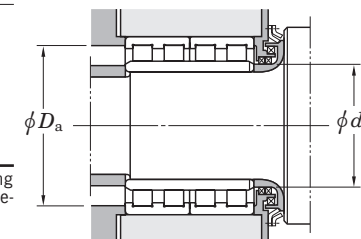

Boundary dimensions (mm)							Basic load ratings (kN)		Bearing No.	Design ¹⁾	Mounting dimensions (mm)					(Refer.) Mass (kg)	
d	D	B	C	F_w	r min.	r_1 min.	C_r	C_{0r}			d_a min.	D_a max.	r_a ²⁾ min.	r_b ²⁾ max.	r_a ²⁾ max.		
280	390	220	220	306	3	2.1	2 520	5 350	313822C 313822D 56FC39240 56FC39275B 56FC39275J 56FC41300	1-2	292	376	364	2.5	2	79.7	
	390	220	220	312	3	3	2 320	5 100			1-2	294	376	366	2.5	2.5	80.1
	390	240	240	312	3	3	2 460	5 620			1-2	294	376	364	2.5	2.5	88.1
	390	275	275	309	2.1	2.1	2 680	6 110			1-2	292	378	363	2	2	100
	390	275	275	308	3	2.1	3 040	6 850			2-4	292	376	366	2.5	2	102
410	300	300	314	3	3	3 730	8 400	2-6P	294	396	378	2.5	2.5	137			
290	390	234	234	320	3	3	2 300	5 500	58FC39234 58FC40180W 58FC41240 58FC42300	1-2	304	376	368	2.5	2.5	80.0	
	400	180	180	320	3	3	1 880	4 010			1-2	304	386	372	2.5	2.5	68.3
	410	240	240	320	3	3	2 610	5 540			1-2	304	396	380	2.5	2.5	99.0
	420	300	300	327	3	3	3 100	6 960			1-2	304	406	387	2.5	2.5	138
300	400	300	300	328	3	3	2 920	7 310	60FC40300A 60FC42218 60FC42240 4CR300 60FC42300DW 60FC42300L-2 60FC42300W	1-2	314	386	378	2.5	2.5	103	
	420	218	218	332	3	3	2 350	5 010			1-1	314	406	390	2.5	2.5	93.0
	420	240	240	332	3	3	2 660	5 750			1-1	314	406	392	2.5	2.5	102
	420	300	300	332	3	3	3 370	7 840		3-2P	314	406	392	2.5	2.5	125	
	420	300	300	331	1.5	1.5	3 420	7 750		2-4	309	411	395	1.5	1.5	127	
	420	300	300	332	2	2	3 750	8 690		2-6P	310	410	395	2	2	129	
	420	300	300	332	3	3	3 250	7 270		2-3	314	406	394	2.5	2.5	127	
310	420	300	300	338	3	3	3 090	7 370	62FC42300 62FC43240 62FC44240	1-2	324	406	394	2.5	2.5	119	
	430	240	240	344.5	3	3	2 640	5 770			1-2	324	416	404	2.5	2.5	105
	440	240	240	341	3	3	2 820	5 730			1-2	324	426	409	2.5	2.5	113
320	440	230	230	351	3	3	2 530	5 490	64FC44230/240 4CR320 64FC45240 64FC45240CW 64FC46340A	1-2	334	426	411	2.5	2.5	103	
	450	240	240	358	3	3	2 700	5 740			1-2	334	436	422	2.5	2.5	119
	450	240	240	355	3	3	2 700	5 730			1-2	334	436	419	2.5	2.5	117
	450	240	240	358	3	3	2 770	5 930			1-4	334	436	422	2.5	2.5	118
	460	340	340	360	3	3	3 860	8 730			1-4	334	446	428	2.5	2.5	187

[Notes] 1) Design numbers indicate the following meanings
 with P pin type cages
 without P machined cages

	Outer ring with rib	Outer ring with loose rib
One inner ring	1-1, 1-2, 1-3, 1-4	1-6P
Two inner rings	2-1P, 2-2, 2-2P, 2-3, 2-4	2-5P, 2-6P
Extended inner ring		3-1, 3-1P, 3-2P

2) r_a indicates housing chamfer dimension corresponding to outer ring chamfer dimension r . r_b indicates the shaft chamfer dimension corresponding to inner ring chamfer dimension r_1 .

Four-row cylindrical roller bearings

d (320) ~ 370 mm

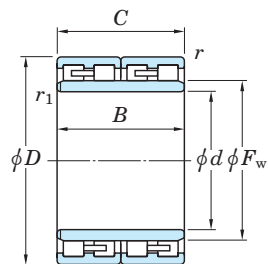

Design 1-1

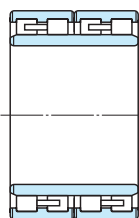

Design 1-2

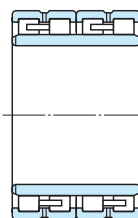

Design 1-3

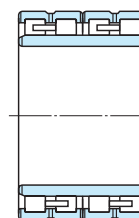

Design 1-4

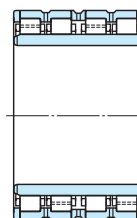

Design 1-6P

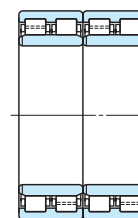

Design 2-1P

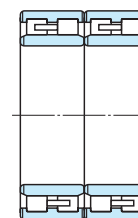

Design 2-2

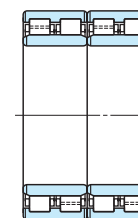

Design 2-2P

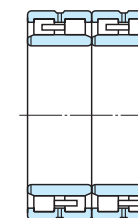

Design 2-3

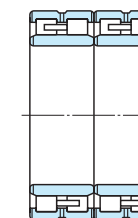

Design 2-4

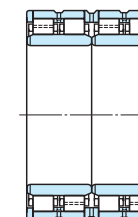

Design 2-5P

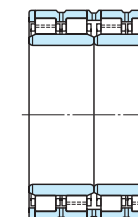

Design 2-6P

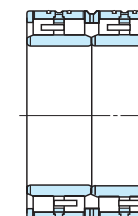

Design 3-1

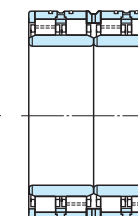

Design 3-1P

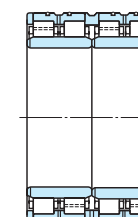

Design 3-2P

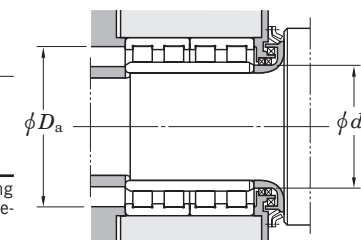

Boundary dimensions (mm)							Basic load ratings (kN)		Bearing No.	Design ¹⁾	Mounting dimensions (mm)					(Refer.) Mass (kg)		
d	D	B	C	F _w	r _{min.}	r ₁ ³⁾ min.	C _r	C _{0r}			d _a min.	D _a max.	r _a ²⁾ min.	r _a ²⁾ max.	r _b ²⁾ max.			
320	480	290	290	361	4	4	4 080	8 450	64FC48290 314274A	2-6P	338	462	441	3	3	189		
	480	350	350	364	2.1	2.1	5 010	11 000			332	468	444	2	2		227	
330	440	200	200	358	3	3	2 340	5 220	66FC44200AW 66FC44200W 66FC46340 66FC46340B 66FC46380W	1-3	344	426	414	2.5	2.5	83.4		
	440	200	200	360	3	5	2 050	4 670			1-3	352	426	412	2.5		4	83.0
	460	340	340	364	2.1	2.1	3 860	9 150			1-2	342	448	428	2		2	172
	460	340	340	368	4	4	4 060	9 800			1-2	348	442	432	3		3	176
	460	380	380	364	2.1	2.1	4 380	10 800			1-4	342	448	428	2		2	195
340	445	250	250	367	2.1	4	2 510	6 110	68FC45250W 68FC45250BW 68FC48350-2 68FC48350D 68FC48350L 68FC48350N 68FC49300 68FC49300A	1-3	358	433	419	2	3	100		
	450	250	250	368	2.1	2.1	2 750	6 480			1-3	352	438	424	2		2	106
	480	350	350	378	4	SP	4 580	11 100			2-4	354	462	446	3		2	211
	480	350	350	378	3	SP	4 780	11 500			3-2P	354	466	448	2.5		2	201
	480	350	350	376	4	4	4 840	11 400			3-2P	358	462	448	3		3	201
	480	385	350	378	2.1	SP	4 780	11 500			2-6P	358	468	448	2		3	209
	490	300	300	380	5	5	3 500	7 690			1-2	362	468	450	4		4	187
	490	300	300	379	5	5	3 680	7 850			1-2	362	468	453	4		4	182
343.052	457.098	254	254	374	3	3	2 640	6 190	69FC46254W	1-4	358	443	430	2.5	2.5	112		
350	500	460	460	388	2	2	6 570	16 500	70FC50460	2-6P	360	490	464	2	2	296		
360	480	290	290	392	3	3	3 470	8 510	72FC48290 72FC50250 72FC51370 72FC52380	1-2	374	466	452	2.5	2.5	145		
	500	250	250	394	3	3	3 510	7 340			2-2	374	486	470	2.5		2.5	145
	510	370	370	400	4	4	4 590	11 000			1-2	378	492	470	3		3	241
	520	380	380	405	2	5	5 800	13 700			2-6P	382	510	485	2		4	270
370	520	380	380	409	5	5	5 320	13 200	74FC52380 74FC52400W 74FC54400A	2-6P	392	498	481	4	4	257		
	520	400	400	413	5	5	4 740	11 900			2-4	392	498	481	4		4	268
	540	400	400	415	4	4	5 190	11 500			1-2	388	522	499	3		3	311

[Notes] 1) Design numbers indicate the following meanings
 with P pin type cages
 without P machined cages

	Outer ring with rib	Outer ring with loose rib
One inner ring	1-1, 1-2, 1-3, 1-4	1-6P
Two inner rings	2-1P, 2-2, 2-2P, 2-3, 2-4	2-5P, 2-6P
Extended inner ring		3-1, 3-1P, 3-2P

2) r_a indicates housing chamfer dimension corresponding to outer ring chamfer dimension r. r_b indicates the shaft chamfer dimension corresponding to inner ring chamfer dimension r₁.
 3) SP indicates the specially chamfered form.

Four-row cylindrical roller bearings

d 375 ~ (420) mm

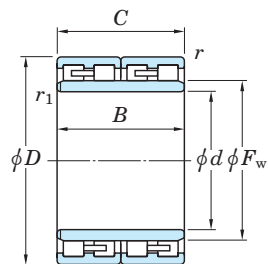

Design 1-1

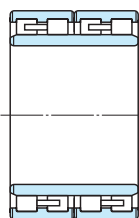

Design 1-2

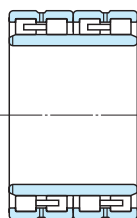

Design 1-3

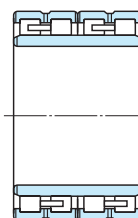

Design 1-4

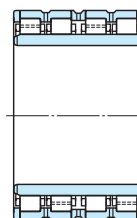

Design 1-6P

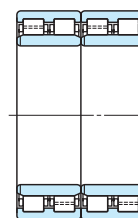

Design 2-1P

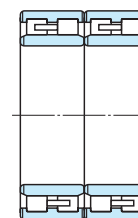

Design 2-2

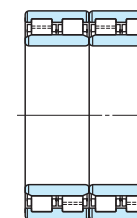

Design 2-2P

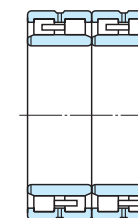

Design 2-3

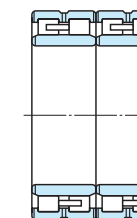

Design 2-4

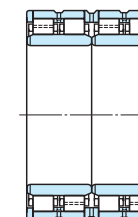

Design 2-5P

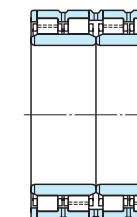

Design 2-6P

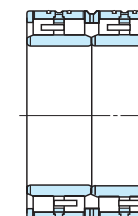

Design 3-1

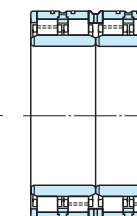

Design 3-1P

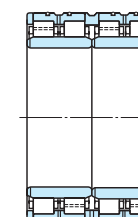

Design 3-2P

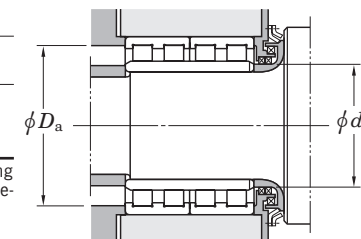

Boundary dimensions (mm)							Basic load ratings (kN)		Bearing No.	Design ¹⁾	Mounting dimensions (mm)					(Refer.) Mass (kg)
d	D	B	C	F _w	r _{min.}	r ₁ ³⁾ min.	C _r	C _{0r}			d _a min.	D _a max.	r _a ²⁾ min.	r _a ²⁾ max.	r _b ²⁾ max.	
375	545	400	400	417	4	4	6 310	14 500	75FC55400	3-2P	393	527	505	3	3	315
380	520	280	280	417	4	4	3 720	8 550	76FC52280	1-2	398	502	487	3	3	173
	520	290	290	418	4	4	3 760	8 840	76FC52290	1-2	398	502	486	3	3	181
	540	300	300	421	3	3	4 650	10 100	76FC54300	2-6P	394	526	505	2.5	2.5	222
	540	340	340	422	4	4	4 600	10 300	76FC54340W	3-1	398	522	502	3	3	256
	540	360	360	422	4	4	5 480	12 900	76FC54360	2-6P	398	522	502	3	3	266
	540	400	380	422	4	4	6 010	14 300	76FC54380	2-6P	398	522	504	3	3	287
	540	400	400	422	4	4	6 040	14 600	76FC54400BW	2-6P	398	522	502	3	3	298
540	400	400	422	4	4	6 040	14 600	76FC54400DW	3-2P	398	522	502	3	3	298	
390	550	400	400	434	5	SP	5 130	12 400	78FC55400AW	2-3	410	528	510	4	4	296
400	520	250	250	432	4	4	2 920	7 100	80FC52250W	1-3	418	502	492	3	3	133
	560	360	360	441	5	5	5 570	13 400	80FC56360	2-6P	422	538	521	4	4	277
	560	410	410	445	5	5	6 330	15 800	4CR400	3-2P	422	538	525	4	4	310
	560	410	410	445	2	5	6 470	16 300	80FC56410	2-6P	422	550	525	2	4	315
	600	380	380	450	5	5	6 610	14 300	80FC60380	2-6P	422	578	552	4	4	388
406.4	609.6	304.8	304.8	460	5	5	4 380	8 750	81FC6130W	1-4	429	587	556	4	4	307
410	546	400	400	448	5	5	5 010	13 000	82FC55400	2-2	432	524	516	4	4	256
	600	440	440	460	5	5	8 070	18 800	82FC60440	2-6P	432	578	560	4	4	432
418.5	600	410	410	470	5	5	6 630	15 700	84FC60410A	2-6P	441	578	560	4	4	385
419	592	350	350	462	4	4	5 690	12 900	84FC59350	1-6P	437	574	552	3	3	304
420	560	280	280	457	4	4	3 930	9 410	84FC56280	1-1	438	542	527	3	3	189
	560	400	400	458	4	4	4 870	12 700	84FC56400	2-4	438	542	526	3	3	270

[Notes] 1) Design numbers indicate the following meanings with P pin type cages without P machined cages

	Outer ring with rib	Outer ring with loose rib
One inner ring	1-1, 1-2, 1-3, 1-4	1-6P
Two inner rings	2-1P, 2-2, 2-2P, 2-3, 2-4	2-5P, 2-6P
Extended inner ring		3-1, 3-1P, 3-2P

2) r_a indicates housing chamfer dimension corresponding to outer ring chamfer dimension r. r_b indicates the shaft chamfer dimension corresponding to inner ring chamfer dimension r₁.
3) SP indicates the specially chamfered form.

Four-row cylindrical roller bearings

d (420) ~ (480) mm

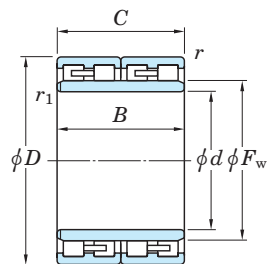

Design 1-1

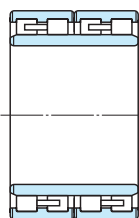

Design 1-2

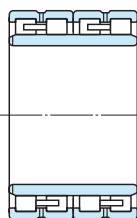

Design 1-3

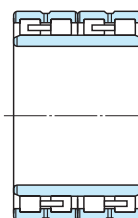

Design 1-4

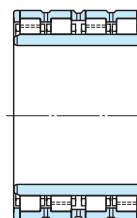

Design 1-6P

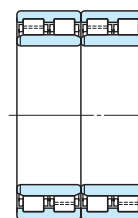

Design 2-1P

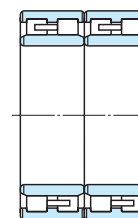

Design 2-2

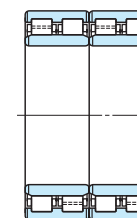

Design 2-2P

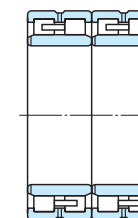

Design 2-3

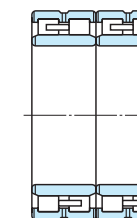

Design 2-4

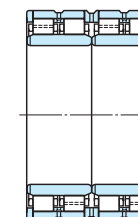

Design 2-5P

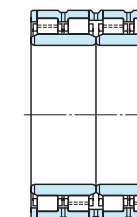

Design 2-6P

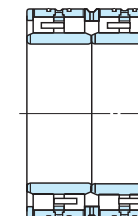

Design 3-1

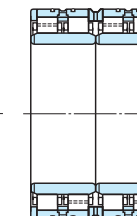

Design 3-1P

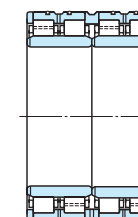

Design 3-2P

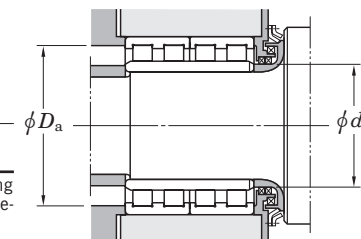

Boundary dimensions (mm)							Basic load ratings (kN)		Bearing No.	Design ¹⁾	Mounting dimensions (mm)				(Refer.) Mass (kg)	
d	D	B	C	F_w	r min.	r_1 ³⁾ min.	C_r	C_{0r}			d_a min.	D_a max.	r_a ²⁾ min.	r_b ²⁾ max.		
420	580	320	320	463	4	4	4 760	11 000	84FC58320 4CR420A	2-4 3-1P	438	562	543	3	3	249
	600	440	440	470	5	5	7 240	17 700			442	578	560	4	4	420
430	591	420	420	472	5	5	6 550	16 800	86FC59420 86FC59420-2 86FC59420A-1 86FC60450	2-2P 2-6P 1-3 2-6P	452	569	552	4	4	345
	591	420	420	476	4	4	6 520	17 400			448	573	552	3	3	349
	591	420	420	476	4	4	5 910	14 700			448	573	552	3	3	340
	600	450	450	475	5	5	7 460	19 300			452	578	559	4	4	405
440	590	270	270	482	4	4	3 620	8 460	88FC59270W 4CR440 88FC62450AW 88FC64420 88FC72452	1-3 3-1P 2-6P 2-6P 1-6P	458	572	554	3	3	207
	620	450	450	487	4	4	7 900	20 000			458	602	577	3	3	440
	620	450	450	487	4	4	7 900	20 000			458	602	577	3	3	440
	640	420	420	492	5	5	7 820	18 400			462	618	592	4	4	470
	720	452	452	512	6	6	8 570	16 600			468	692	652	5	5	740
444.5	660.4	323.85	323.85	500	4	4	6 040	12 600	89FC66324	1-6P	463	642	608	3	3	400
445	635	375	375	496	4	4	6 240	14 600	4CR445	3-1P	463	617	588	3	3	385
450	630	450	450	500	4	4	6 820	16 600	90FC63450A	2-2	468	612	590	3	3	433
460	600	400	400	497	4	SP	5 300	14 300	92FC60400 4CR460C 92FC62400BW 92FC62400D 92FC65470W 4CR460 92FC66500 4CR460D	2-4 3-1P 1-6P 1-4 1-6P 3-1P 2-6P 3-1P	478	582	567	3	3	287
	620	400	400	504	4	4	6 850	18 200			478	602	584	3	3	350
	620	400	400	502	4	4	6 510	17 000			478	602	582	3	3	350
	620	400	400	502	4	4	5 900	14 800			478	602	583	3	3	340
	650	470	470	509	6	6	8 990	22 200			488	622	609	5	5	494
	660	500	500	512	4	4	9 310	23 300			478	642	612	3	3	590
	660	500	500	510	5	5	9 540	23 400			482	638	614	4	4	573
	680	400	400	504	4	4	7 910	16 600			478	662	624	3	3	510
	480	650	450	450	525	5	5	8 480			22 400	96FC65450B	2-6P	502	628	615

[Notes] 1) Design numbers indicate the following meanings
with P pin type cages
without P machined cages

	Outer ring with rib	Outer ring with loose rib
One inner ring	1-1, 1-2, 1-3, 1-4	1-6P
Two inner rings	2-1P, 2-2, 2-2P, 2-3, 2-4	2-5P, 2-6P
Extended inner ring		3-1, 3-1P, 3-2P

2) r_a indicates housing chamfer dimension corresponding to outer ring chamfer dimension r . r_b indicates the shaft chamfer dimension corresponding to inner ring chamfer dimension r_1 .
3) SP indicates the specially chamfered form.

Four-row cylindrical roller bearings

d (480) ~ 500 mm

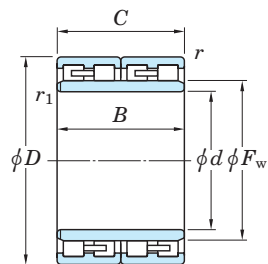

Design 1-1

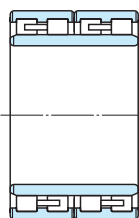

Design 1-2

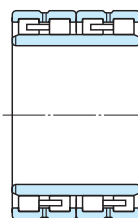

Design 1-3

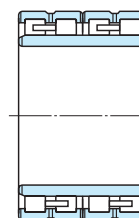

Design 1-4

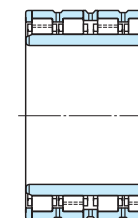

Design 1-6P

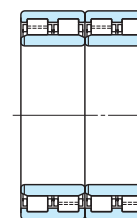

Design 2-1P

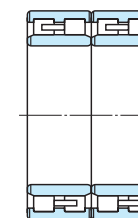

Design 2-2

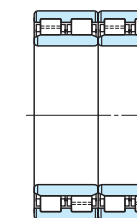

Design 2-2P

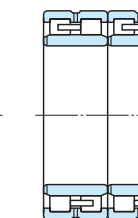

Design 2-3

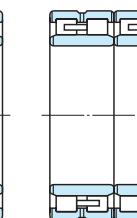

Design 2-4

d	Boundary dimensions (mm)					$r^{(3)}$ min.		Basic load ratings (kN)		Bearing No.	Design ¹⁾	Mounting dimensions (mm)					(Refer.) Mass (kg)
	D	B	C	F_w	$r_1^{(3)}$ min.	C_r	C_{0r}	d_a min.	D_a max.			$r_a^{(2)}$ max.	$r_b^{(2)}$ max.				
480	650	460	460	526	5	5	7 730	20 800	96FC65460	2-6P	502	628	610	4	4	443	
	680	460	460	532	5	5	8 620	21 300	96FC68460	2-6P	502	658	632	4	4	545	
	680	500	500	534	5	5	8 620	22 000	4CR480	3-1P	502	658	630	4	4	580	
	680	500	500	534	5	5	8 620	22 000	4CR480B	3-2P	502	658	630	4	4	580	
	680	500	500	532	5	5	9 550	24 300	96FC68500A	2-6P	502	658	632	4	4	595	
495	615	360	360	530	SP	SP	4 030	12 000	99FC62360	2-4	511	597	586	3	3	235	
500	670	450	450	540	5	SP	8 460	22 500	100FC67450A-3	2-6P	522	648	630	4	4	451	
	680	420	405	550	5	5	6 710	17 600	100FC68405	2-6P	522	658	634	4	4	442	
	680	450	450	542.5	4	4	8 980	23 100	100FC68450	2-6P	518	662	639	3	3	495	
	690	510	510	550	5	5	9 350	24 600	100FC69510A	3-2P	522	668	646	4	4	562	
	710	480	480	558	6	6	9 770	24 800	100FC71480	2-6P	528	682	662	5	5	631	
	720	400	400	558	5	6	8 320	18 900	100FC72400	1-6P	528	698	672	4	5	549	
	720	530	530	560	6	6	10 800	26 500	100FC72530	2-6P	528	692	674	5	5	725	
	720	530	530	568	5	4	11 000	28 900	100FC72530C	2-6P	518	698	672	4	3	742	
	720	530	530	560	6	6	10 800	26 500	100FC72530W	3-2P	528	692	674	5	5	725	

[Notes] 1) Design numbers indicate the following meanings
 with P pin type cages
 without P machined cages

	Outer ring with rib	Outer ring with loose rib
One inner ring	1-1, 1-2, 1-3, 1-4	1-6P
Two inner rings	2-1P, 2-2, 2-2P, 2-3, 2-4	2-5P, 2-6P
Extended inner ring		3-1, 3-1P, 3-2P

2) r_a indicates housing chamfer dimension corresponding to outer ring chamfer dimension r . r_b indicates the shaft chamfer dimension corresponding to inner ring chamfer dimension r_1 .
 3) SP indicates the specially chamfered form.

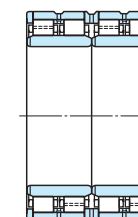

Design 2-5P

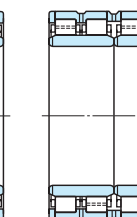

Design 2-6P

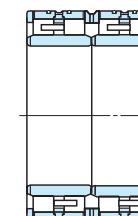

Design 3-1

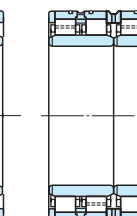

Design 3-1P

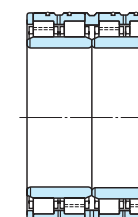

Design 3-2P

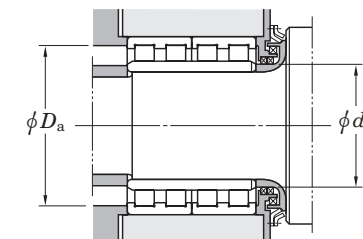

Four-row tapered roller bearings

d 65 ~ 133.350 mm

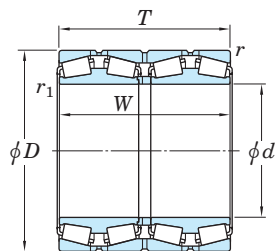

Design 1

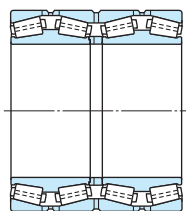

Design 1-P

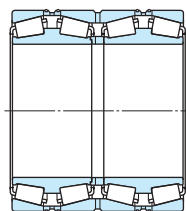

Design 2

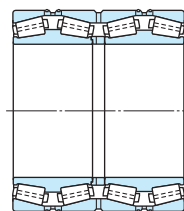

Design 2-P

For oil mist lubrication

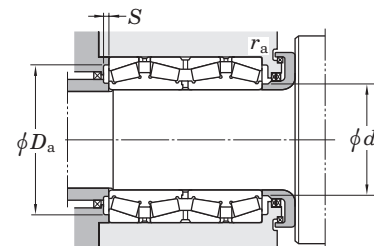

Boundary dimensions (mm)						Basic load ratings (kN)		Bearing No. ¹⁾	Design	Mounting dimensions (mm)						Constant e	Axial load factors			(Refer.) Mass (kg)
d	D	T	W	$r_{min.}$	$r_{1 min.}$	C_r	C_{0r}			d_a max.	D_a max.	D_a min.	S min.	r_a max.	r_b ²⁾ max.		Y_2	Y_3	Y_0	
65	100	98	98	1.5	0.3	309	550	47T131010	1	73	91.5	87	3.6	1.5	0.3	0.46	1.47	2.19	1.44	2.82
80	115	88	88	1.5	1.5	265	543	47T1611	1	91	106.5	102	3.4	1.5	1.5	0.33	2.03	3.02	1.98	2.99
95	130	100	100	1.5	1.5	347	729	47T191310	1	104	121.5	117	3.5	1.5	1.5	0.33	2.03	3.02	1.98	3.83
100	140	104	104	2	2.5	338	661	37220	1	112	130	125	3.8	2	2	0.28	2.37	3.53	2.32	4.6
	140	104	104	2	1	407	852	37220A	1	110	130	125	4.1	2	1	0.40	1.68	2.50	1.64	4.8
	170	155	155	2	2.5	787	1 470	47T2017	1	119	160	149	5.7	2	2	0.35	1.95	2.90	1.91	14.7
105	160	150	150	1.5	1	747	1 420	47T211615	1	118	151.5	146	5.9	1.5	1	0.33	2.03	3.02	1.98	10.6
110	155	114	114	2	2.5	475	955	37222	1	121	145	140	4.8	2	2	0.33	2.03	3.02	1.98	6.45
	160	115	115	1.5	1	548	1 030	47T221612	1	121	151.5	146	5.2	1.5	1	0.43	1.57	2.34	1.53	7.63
	180	154	154	2	2.5	882	1 530	47T221815	1	127	170	162	5.9	2	2	0.39	1.74	2.59	1.70	15.4
	180	170	170	1	1	989	1 770	47T221817	1	126	174.5	162	6.5	1	1	0.33	2.03	3.02	1.98	17
115	155	115	115	1.5	0.6	437	1 020	47T231612A	1	126	146.5	142	3.4	1.5	0.6	0.40	1.68	2.50	1.64	6.12
	160	120	120	1.5	0.6	560	1 160	47T231612	1	124	151.5	147	5.7	1.5	0.6	0.35	1.95	2.90	1.91	7.2
120	170	124	124	2	2.5	472	943	37224	1	135	160	155	4.1	2	2	0.28	2.37	3.53	2.32	8.56
	170	130	130	1.5	2	591	1 290	47T241713	1	133	161.5	155	4.4	1.5	2	0.40	1.68	2.50	1.64	9.38
	200	132	132	2	2.5	706	1 200	47324	1	143	190	178	5.7	2	2	0.35	1.95	2.90	1.91	16.5
	210	174	174	2.5	3	1 110	1 770	47T242117	1	143	198	188	4	2	2.5	0.33	2.03	3.02	1.98	24.5
120.650	161.925	106.365	106.365	1.6	1.6	322	771	L624549D/514/514D	1	130	153	147	5.1	1.6	1.6	0.43	1.56	2.32	1.52	6.24
	166.688	152.414	152.400	3.3	1.6	637	1 460	LM124449D/410/410D	1	132	155	150	2.3	3.3	1.6	0.29	2.30	3.42	2.25	9.84
	174.625	139.703	141.288	1.6	0.8	712	1 450	M224749D/710/710D	1	133	166	159	4.9	1.6	0.8	0.33	2.03	3.02	1.98	11.1
127.000	182.563	158.750	158.750	3.2	1.6	778	1 720	48290D/20/20D	1	140	171	166	3.7	3.2	1.6	0.31	2.21	3.29	2.16	13.6
130	184	134	134	2	2.5	645	1 330	37226	1	143	174	169	4.3	2	2	0.33	2.03	3.02	1.98	11
133.350	196.850	193.675	193.675	3.2	1.6	1 070	2 240	67390D/22/22D	1	148	185	180	5.6	3.2	1.6	0.34	1.96	2.92	1.92	19.8

[Notes] 1) While metric series bearings have minus tolerances for bore and OD, inch series have plus tolerances. Refer to page C 82 for details of applicable tolerance standards.

2) r_b indicates the shaft chamfer dimension corresponding to cone chamfer dimension r_1 .

Four-row tapered roller bearings

d 135 ~ 170 mm

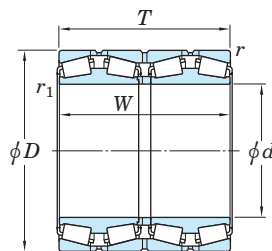

Design 1

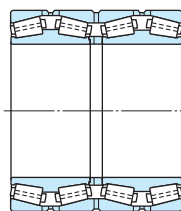

Design 1-P

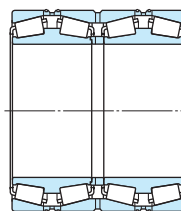

Design 2

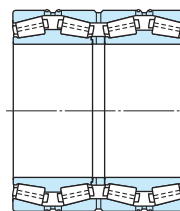

Design 2-P

For oil mist lubrication

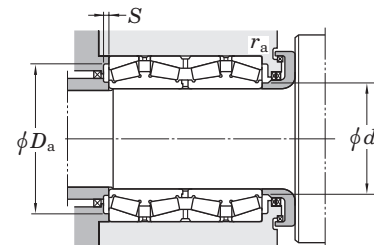

Boundary dimensions (mm)						Basic load ratings (kN)		Bearing No. ¹⁾	Design	Mounting dimensions (mm)					Constant e	Axial load factors			(Refer.) Mass (kg)	
d	D	T	W	r min.	r1 min.	Cr	Cor			da max.	Da max.	Da min.	S min.	ra max.		rb ²⁾ max.	Y2	Y3		Y0
135	180	160	160	1.5	1	559	1 290	47T271816	1	146	171.5	166	1.4	1.5	1	0.33	2.03	3.02	1.98	10.7
	195	160	160	1.5	0.6	938	1 930	47T272016	1	147	186.5	179	3.9	1.5	0.6	0.33	2.03	3.02	1.98	15.4
136.525	190.500	161.925	161.925	3.2	1.6	809	1 890	47T271916	2	150	179	174	4.8	3.2	1.6	0.32	2.10	3.13	2.06	14.3
	190.500	161.925	161.925	3.2	1.6	809	1 890	48393D/20/20D	1	150	179	174	4.8	3.2	1.6	0.32	2.10	3.13	2.06	14.3
139.700	200.025	160.340	157.166	3.3	0.8	844	1 960	48680D/20/20D	1	157	187	182	4	3.3	0.8	0.34	2.01	2.99	1.96	16.6
140	198	144	144	2	2.5	770	1 650	37228	1	157	188	183	5.3	2	2	0.28	2.43	3.61	2.37	13.6
	210	114	114	2	2.5	623	1 130	47228	1	160	200	190	6	2	2	0.27	2.47	3.67	2.41	13.7
	225	145	145	2.5	3	973	1 610	47328	1	161	213	203	6.5	2	2.5	0.40	1.68	2.50	1.64	21.2
145	195	130	130	1.5	0.6	641	1 550	47T292013	1	158	186.5	177	5.1	1.5	0.6	0.40	1.68	2.50	1.64	11.1
150	210	190	190	2	0.6	993	2 270	47T302119	1	163	200	190	5	2	0.6	0.39	1.74	2.59	1.70	20.2
	212	155	155	2.5	3	774	1 640	37230	1	168	200	190	6	2	2.5	0.28	2.37	3.53	2.32	16.7
152.400	222.250	174.625	174.625	1.6	1.6	1 080	2 390	M231649D/610/610D	1	168	213	201	6	1.6	1.6	0.33	2.03	3.02	1.98	22.8
160	226	165	165	2.5	3	873	1 870	37232	1	178	214	204	6	2	2.5	0.28	2.37	3.53	2.32	20.1
	250	145	145	2.5	3	1 090	1 870	47T322515	1	182	238	226	6.5	2	2.5	0.33	2.03	3.02	1.98	25.4
	265	173	173	2.5	1	1 320	2 400	47T322717	1	193	253	241	7	2	1	0.35	1.95	2.90	1.91	37.6
165.100	225.425	168.275	165.100	3.2	0.8	868	2 140	46791D/20/21D	1	180	213	203	4.5	3.2	0.8	0.38	1.77	2.63	1.73	19.7
168.275	247.650	192.088	192.088	3.2	1.6	1 190	2 800	67782D/20/21D	1	189	236	226	5	3.2	1.6	0.44	1.54	2.29	1.50	31.7
170	230	175	175	2	1	1 030	2 370	47T342318	1	183	220	210	6	2	1	0.40	1.68	2.50	1.64	19.9
	240	175	175	2.5	3	1 020	2 310	37234A	1	189	228	218	5	2	2.5	0.33	2.03	3.02	1.98	24.2
	240	175	175	2.5	1.5	1 120	2 340	47T342418A	2	184	228	218	7.5	2	1.5	0.40	1.68	2.50	1.64	24.7
	260	160	160	2.5	3	1 110	1 900	47T342616	1	194	248	238	6	2	2.5	0.35	1.95	2.90	1.91	28.5
	280	181	181	2.5	3	1 330	2 420	47334/181	1	202	268	250	6	2	2.5	0.33	2.03	3.02	1.98	44
	280	185	185	2.5	3	1 330	2 420	47334	1	202	268	250	6	2	2.5	0.33	2.03	3.02	1.98	44.8

[Notes] 1) While metric series bearings have minus tolerances for bore and OD, inch series have plus tolerances. Refer to page C 82 for details of applicable tolerance standards.

2) rb indicates the shaft chamfer dimension corresponding to cone chamfer dimension r1.

Four-row tapered roller bearings

d 177.800 ~ 205 mm

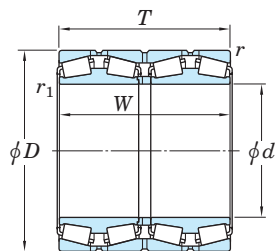

Design 1

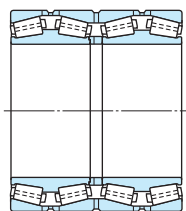

Design 1-P

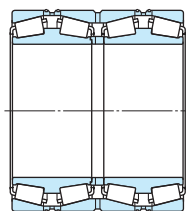

Design 2

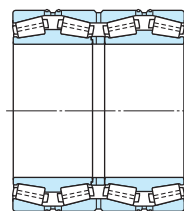

Design 2-P

For oil mist lubrication

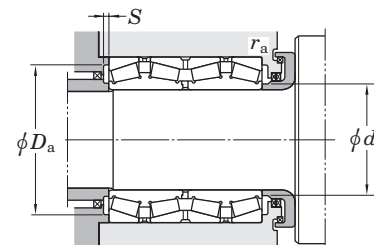

Boundary dimensions (mm)						Basic load ratings (kN)		Bearing No. ¹⁾	Design	Mounting dimensions (mm)						Constant e	Axial load factors			(Refer.) Mass (kg)
d	D	T	W	r min.	r_1 min.	C_r	C_{0r}			d_a max.	D_a max.	D_a min.	S min.	r_a max.	r_b ²⁾ max.		Y_2	Y_3	Y_0	
177.800	247.650	192.088	192.088	3.2	1.6	1 190	2 800	67791D/20/21D	1	189	235	225	5	3.2	1.6	0.44	1.54	2.29	1.50	28.4
	279.400	234.948	234.950	3.2	1.6	1 660	3 290	82681D/20/20D	1	197	267	251	6.5	3.2	1.6	0.52	1.29	1.92	1.26	52.5
	285.750	222.245	222.500	3.2	1.6	1 520	2 860	EE91700D/112/113XD	1	201	273	251	3.5	3.2	1.6	0.43	1.57	2.34	1.53	53.7
180	250	185	185	2.5	3	1 140	2 550	47T362519	1	198	238	228	6	2	2.5	0.33	2.03	3.02	1.98	26.9
	254	185	185	2.5	3	1 140	2 550	37236	1	198	242	232	6	2	2.5	0.33	2.03	3.02	1.98	29.1
	260	160	160	2.5	1	1 090	2 090	47T362616	1	198	248	238	5	2	1	0.37	1.80	2.69	1.76	26.4
	260	200	200	2	2.5	1 390	2 950	47T362620	1	200	250	240	4.5	2	2	0.31	2.15	3.20	2.10	33.6
	280	181	181	2.5	3	1 510	2 830	47T362818A	1	204	268	253	8	2	2.5	0.33	2.03	3.02	1.98	40.8
	300	202	202	3	4	1 580	2 750	47336	1	211	286	267	5.5	2.5	3	0.35	1.95	2.90	1.91	54.9
	300	280	280	3	4	2 400	4 430	47T363028	1	211	286	270	6	2.5	3	0.33	2.03	3.02	1.98	78.4
187	270	210	210	2.5	1	1 660	3 570	47T372721B	1	205	258	248	8	2	1	0.33	2.03	3.02	1.98	39.1
187.325	269.875	211.138	211.138	3.2	1.6	1 410	3 220	M238849D/810/810D	1	206	257	245	5	3.2	1.6	0.33	2.03	3.02	1.98	39.5
190	268	196	196	2.5	3	1 210	2 760	37238	1	210	256	246	6	2	2.5	0.33	2.03	3.02	1.98	33.4
	270	160	160	2.5	1	1 170	2 370	47T382716	1	208	258	248	7	2	1	0.40	1.68	2.50	1.64	28.3
190.000	270.000	190.000	190.000	3.2	1.6	1 160	2 810	4TR3827	1	208	257	244	6	3.2	1.6	0.48	1.42	2.11	1.38	34.7
190.500	266.700	188.913	187.325	3.2	1.6	1 160	2 810	67885D/67820/67820D	1	208.5	255.3	245.1	6	3.2	1.6	0.48	1.42	2.11	1.38	32.4
198.438	284.163	225.425	225.425	3.2	1.6	1 740	3 780	M240648D/611/611D	1	215	271	260	5	3.2	1.6	0.33	2.03	3.02	1.98	44.7
200	280	206	206	2.5	1.5	1 670	3 830	47T402821	1	216	268	258	6.5	2	1.5	0.39	1.71	2.54	1.67	39.7
	282	206	206	2.5	3	1 490	3 380	37240	1	223	270	260	5.5	2	2.5	0.28	2.43	3.61	2.37	39.6
	340	234	234	3	4	2 340	4 150	47T403423	1	234	326	302	6	2.5	4	0.40	1.68	2.50	1.64	86
203.200	317.500	209.550	215.900	3.2	3.2	1 510	2 900	EE132082D/125/126D	1	235	304	284	7	3.2	3.2	0.31	2.15	3.21	2.11	61
	317.500	266.700	266.700	3.2	1.6	2 070	4 540	93800D/125/127D	1	223	304	278	6.5	3.2	1.6	0.52	1.29	1.92	1.26	78.8
205	320	205	205	3	4	1 740	3 030	47T413221	1	230	306	292	7.5	2.5	3	0.46	1.46	2.17	1.42	58.9

[Notes] 1) While metric series bearings have minus tolerances for bore and OD, inch series have plus tolerances. Refer to page C 82 for details of applicable tolerance standards.

2) r_b indicates the shaft chamfer dimension corresponding to cone chamfer dimension r_1 .

Four-row tapered roller bearings

d 206.375 ~ 235 mm

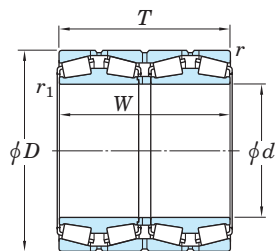

Design 1

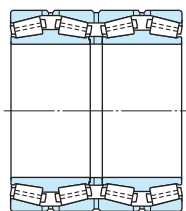

Design 1-P

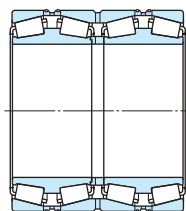

Design 2

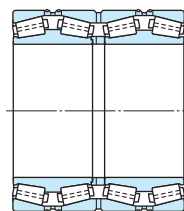

Design 2-P

For oil mist lubrication

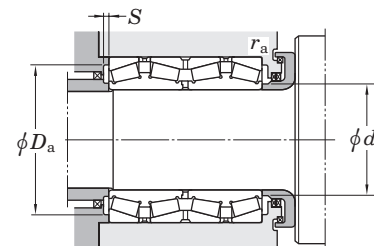

Boundary dimensions (mm)						Basic load ratings (kN)		Bearing No. ¹⁾	Design	Mounting dimensions (mm)						Constant e	Axial load factors			(Refer.) Mass (kg)
d	D	T	W	r min.	r_1 min.	C_r	C_{0r}			d_a max.	D_a max.	D_a min.	S min.	r_a max.	r_b ²⁾ max.		Y_2	Y_3	Y_0	
206.375	282.575	184.150	184.150	3.2	0.8	1 200	2 830	67985D/20/20D	1	219	270	259	7	3.2	0.8	0.51	1.33	1.97	1.30	33.9
	282.575	190.500	190.500	3.2	0.8	1 200	2 830	67986D/20/21D	1	222	270	259	7	3.2	0.8	0.51	1.33	1.97	1.30	34.8
	282.575	210.000	210.000	3.2	0.8	1 380	3 010	47T412821A	1	219	270	260	3.5	3.2	0.8	0.43	1.57	2.34	1.53	36.2
215.090	311.150	228.600	228.600	3.2	1.6	1 750	4 040	47T433123	1	233	297	278	7	3.2	1.6	0.40	1.68	2.50	1.64	57.5
215.900	288.925	177.800	177.800	3.2	0.8	1 220	3 120	LM742749D/714/714D	1	229	276	265	5.5	3.2	0.8	0.48	1.40	2.09	1.37	32.8
	336.550	266.700	266.700	3.2	6.4	2 430	4 760	47T433427	1	238	323	304	6.5	3.2	6.4	0.50	1.34	2.00	1.32	85.1
216.103	330.200	269.875	263.525	3.2	1.6	2 500	5 120	47T433327	1	237	316	300	7	3.2	1.6	0.46	1.47	2.19	1.44	81.6
220	300	230	230	2.5	3	1 750	4 040	47T443023	1	231	288	278	6.5	2	2.5	0.40	1.68	2.50	1.64	45.1
	310	226	226	3	4	1 690	3 880	37244	1	242	296	285	6	2.5	3	0.33	2.03	3.02	1.98	52
	320	201	201	3	3	1 660	3 760	47T443220	1	247	306	290	5.5	2.5	2.5	0.33	2.03	3.02	1.98	52.4
	320	250	250	2.5	3	1 930	4 230	47T443225	1	244	308	293	6.5	2	2.5	0.35	1.95	2.90	1.91	64.7
	330	260	260	3	1	2 350	5 070	47T443326A	1	243	316	299	9	2.5	1	0.40	1.68	2.50	1.64	78.4
	330	260	260	3	1	2 330	4 860	47T443326B	2	238	316	300	8	2.5	1	0.55	1.24	1.84	1.21	77.5
	340	190	190	3	4	1 490	2 910	47244	1	260	326	308	6	2.5	3	0.28	2.43	3.61	2.37	62.2
	340	280	280	3	1	2 720	5 580	47T443428-1	1	247	326	308	10	2.5	1	0.33	2.03	3.02	1.98	95.1
340	305	305	3	4	2 910	5 940	47T443431	1	244	326	307	8	2.5	3	0.35	1.95	2.90	1.91	99.6	
220.662	314.325	290.000	290.000	3.2	1.6	2 300	5 050	47T443129A	1	240	300	289	4.5	3.2	1.6	0.33	2.03	3.02	1.98	70
220.663	314.325	239.713	239.713	3.2	1.6	2 100	4 890	M244249D/210/210D	1	241	300	288	5	3.2	1.6	0.33	2.03	3.02	1.98	59
225	320	230	230	2	2.5	1 670	3 730	4TR225A	1	246	310	293	5	2	2	0.37	1.80	2.69	1.76	57
228.600	311.150	200.025	200.025	3.2	1.6	1 660	3 760	LM245149D/110/110D	1	247	297	287	5.5	3.2	1.6	0.33	2.03	3.02	1.98	41.8
230	315	190	190	2	2.5	1 510	3 470	47T463119	1	248	305	290	7.5	2	2	0.37	1.80	2.69	1.76	43
234.950	327.025	196.850	196.850	3.2	1.6	1 600	3 720	8576D/20/20D	1	255	313	299	5.5	3.2	1.6	0.41	1.66	2.47	1.62	50.1
235	325	240	240	2.5	1.5	2 200	5 310	47T473324	1	254	313	301	8.5	2	1.5	0.33	2.03	3.02	1.98	60.5

[Notes] 1) While metric series bearings have minus tolerances for bore and OD, inch series have plus tolerances. Refer to page C 82 for details of applicable tolerance standards.

2) r_b indicates the shaft chamfer dimension corresponding to cone chamfer dimension r_1 .

Four-row tapered roller bearings

d 240 ~ (260) mm

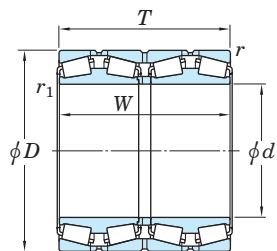

Design 1

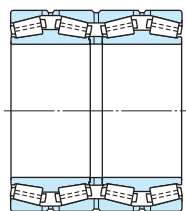

Design 1-P

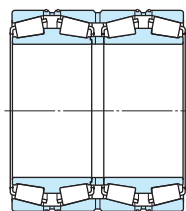

Design 2

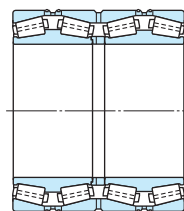

Design 2-P

For oil mist lubrication

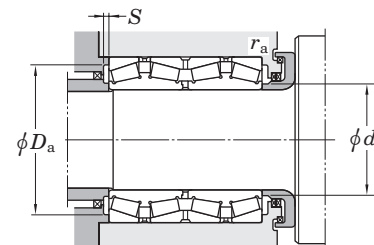

Boundary dimensions (mm)						Basic load ratings (kN)		Bearing No. ²⁾	Design	Mounting dimensions (mm)						Constant e	Axial load factors			(Refer.) Mass (kg)
d	D	T	W	r min.	r ₁ ¹⁾ min.	C _r	C _{0r}			d _a max.	D _a max.	S min.	r _a max.	r _b ³⁾ max.	Y ₂		Y ₃	Y ₀		
240	320	250	250	2	1	1 880	4 760	47T483225B	1	257	310	299	7.5	2	1	0.33	2.03	3.02	1.98	54.2
	338	248	248	3	4	2 360	5 360	37248	1	259	324	312	8.5	2.5	3	0.39	1.74	2.59	1.70	68.4
	338	248	248	3	4	2 360	5 360	37248/DP1	2	259	324	312	8.5	2.5	3	0.39	1.74	2.59	1.70	68.4
	360	194	194	3	4	1 830	3 580	47248	1	272	346	327	8.5	2.5	3	0.32	2.12	3.15	2.07	66.5
	360	214	214	3	2.5	2 170	4 340	47T483621	1	268	346	328	9	2.5	2.5	0.40	1.68	2.50	1.64	75.4
	360	308.5	308.5	3	2.5	3 320	7 400	47T483631A	1	268	346	329	9.5	2.5	2.5	0.26	2.55	3.80	2.50	112
	365	290	290	2	SP	2 870	5 930	47T483729	1	265	355	333	9	2	0.8	0.46	1.47	2.19	1.44	108
410	270	270	4	2.5	3 220	5 520	47T484127A	1	281	392	369	8.5	3	2	0.40	1.68	2.50	1.64	144	
241.478	349.148	228.600	228.600	3.2	1.6	2 190	4 920	47T483523A	1	267	335	319	8.5	3.2	1.6	0.35	1.91	2.84	1.86	72.9
	349.148	228.600	228.600	3.2	1.6	1 900	4 100	EE127097D/135/136D	1	267	335	319	5.5	3.2	1.6	0.35	1.91	2.84	1.86	70.4
244.475	327.025	193.675	193.675	3.2	1.6	1 470	3 500	47T493319	1	259	313	303	5.5	3.2	1.6	0.55	1.24	1.84	1.21	44.4
	327.025	193.675	193.675	3.2	1.6	1 570	3 780	LM247748D/710/710D	1	265	313	305	7.5	3.2	1.6	0.32	2.10	3.13	2.06	44.4
	381.000	304.800	304.800	4.8	3.2	2 700	5 870	EE126096D/150/151D	1	269	364	336	6	4.8	3.2	0.52	1.31	1.95	1.28	129
247.650	400.050	253.995	249.235	6.4	1.6	2 600	5 140	EE220975D/1575/1576D	1	292	379	359	7.5	6.4	1.6	0.39	1.71	2.54	1.67	123
250	350	240	240	2.5	1	2 180	4 970	47T503524	1	270	338	324	6	2	1	0.40	1.68	2.50	1.64	70
	365	270	270	3	1.5	2 650	6 340	47T503627	1	277	351	330	8	2.5	1.5	0.33	2.03	3.02	1.98	96.7
254.000	358.775	147.000	147.000	3.2	1.6	1 320	2 910	47T513615	1	290	345	331	7	3.2	1.6	0.33	2.03	3.02	1.98	46.9
	358.775	269.875	269.875	3.2	1.6	2 650	6 340	47T513627A	2	277	345	330	8	3.2	1.6	0.33	2.03	3.02	1.98	85.8
	358.775	269.875	269.875	3.2	1.6	2 630	6 030	47T513627B	1	272	345	331	7.5	3.2	1.6	0.46	1.47	2.19	1.44	85.5
	358.775	269.875	269.875	3.2	1.6	2 630	6 030	47T513627C	2	272	345	331	7.5	3.2	1.6	0.46	1.47	2.19	1.44	86.1
	358.775	269.875	269.875	3.2	3.2	2 650	6 340	M249748D/710/710D	1	277	345	330	8	3.2	3.2	0.33	2.03	3.02	1.98	86
260	360	272	272	3	1	2 910	7 020	47T523627A	1	280	346	335	9	2.5	1	0.33	2.03	3.02	1.98	83.6
	368	268	268	4	5	2 510	6 020	37252	1	286	350	338	6	3	4	0.33	2.03	3.02	1.98	88.4
	400	220	220	4	1.5	2 390	4 520	47T524022	1	295	382	364	7.5	3	1.5	0.40	1.68	2.50	1.64	98.5
	400	255	255	7.5	5	2 620	5 400	47T524026	1	296	400	360	9	6	4	0.39	1.72	2.56	1.68	113
	400	320	320	4	5	3 270	7 070	47T524032	1	294	382	361	8.5	3	4	0.33	2.03	3.02	1.98	145

[Notes] 1) SP indicates the specially chamfered form.
 2) While metric series bearings have minus tolerances for bore and OD, inch series have plus tolerances. Refer to page C 82 for details of applicable tolerance standards.

3) r_b indicates the shaft chamfer dimension corresponding to cone chamfer dimension r₁.

Four-row tapered roller bearings

d (260) ~ 288.925 mm

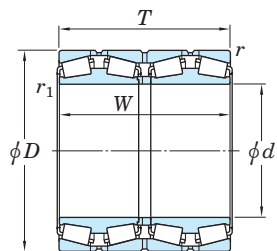

Design 1

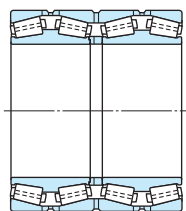

Design 1-P

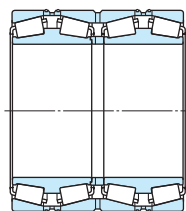

Design 2

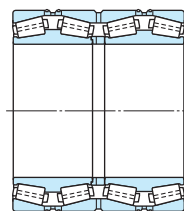

Design 2-P

For oil mist lubrication

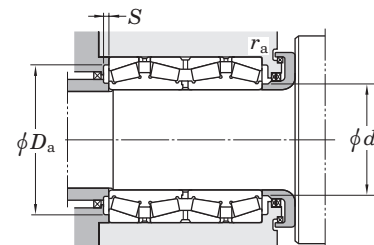

Boundary dimensions (mm)						Basic load ratings (kN)		Bearing No. ¹⁾	Design	Mounting dimensions (mm)						Constant e	Axial load factors			(Refer.) Mass (kg)
d	D	T	W	$r_{min.}$	$r_{1 min.}$	C_r	C_{0r}			d_a max.	D_a max.	D_a min.	S min.	r_a max.	r_b ²⁾ max.		Y_2	Y_3	Y_0	
260	440	300	300	4	5	3 470	6 880	47352	1	311	422	392	10	3	4	0.35	1.95	2.90	1.91	188
260.350	422.275	317.500	314.325	3.2	6.4	3 470	6 720	HM252348D/310/310D	1	304	407	384	1	3.2	6.4	0.33	2.03	3.02	1.98	167
266.700	335.600	228.600	230.188	3.2	1.6	1 850	5 260	47T533423	1	281	322	312	7	3.2	1.6	0.28	2.43	3.61	2.37	46.4
	355.600	228.600	230.188	3.2	1.6	2 230	5 690	47T533623B	1	285	342	332	8	3.2	1.6	0.36	1.87	2.79	1.83	62.7
	355.600	228.600	230.188	3.2	1.6	1 980	4 830	76589D/20/20D	1	285	342	331	7	3.2	1.6	0.37	1.83	2.73	1.79	59.8
	393.700	269.878	269.878	6.4	1.6	2 990	6 460	47T533927-1	1	294	373	361	8.5	6.4	1.6	0.40	1.68	2.50	1.64	112
269.875	381.000	282.575	282.575	3.2	3.2	2 930	6 690	M252349D/310/310D	1	291	367	350	6	3.2	3.2	0.33	2.03	3.02	1.98	98.4
270	364	260	260	3	1.5	2 370	5 720	47T543626	1	285	350	338	4.5	2.5	1.5	0.42	1.59	2.37	1.56	72.8
	410	222	222	4	5	2 250	4 380	47254	1	308	392	372	6.5	3	4	0.27	2.51	3.74	2.45	100
276.225	393.700	269.878	269.878	6.4	1.6	2 730	5 830	47T553927	1	299	373	363	4.5	6.4	1.6	0.40	1.68	2.50	1.64	101
279.400	393.700	269.875	269.875	6.4	1.6	2 660	5 990	47T563927A	2	305	373	363	9.5	6.4	1.6	0.40	1.68	2.50	1.64	101
	393.700	269.875	269.875	6.4	1.6	2 660	5 990	47T563927B	1	305	373	363	9.5	6.4	1.6	0.40	1.68	2.50	1.64	101
	410.000	310.000	310.000	6.4	1.6	3 120	7 290	47T564131	2	308	389	374	8	6.4	1.6	0.40	1.68	2.50	1.64	140
279.578	380.898	244.475	244.475	3.2	1.6	2 280	5 650	LM654644D/610/610D	1	303	367	356	6.5	3.2	1.6	0.43	1.57	2.34	1.53	80.4
280	380	290	290	2	2	2 810	6 940	47T563829	1	300	370	354	6	2	2	0.33	2.03	3.02	1.98	91.8
	380	290	290	2	1	2 810	6 940	47T563829A	2	300	370	354	6	2	1	0.33	2.03	3.02	1.98	92.1
	395	288	288	4	2	2 880	6 900	37256X	1	303	377	363	8	3	2	0.40	1.68	2.50	1.64	110
	395	288	288	4	2	2 880	6 900	47T564029A	2	303	377	363	8	3	2	0.40	1.68	2.50	1.64	110
	420	225	225	4	5	2 390	4 950	47256	1	322	402	382	8.5	3	4	0.25	2.69	4.00	2.63	104
	460	324	324	5	6	4 300	8 230	47T564632	1-P	321	438	415	10.5	4	5	0.46	1.47	2.19	1.44	214
280.268	379.887	244.475	244.475	3.2	1.6	2 280	5 650	47T563824	1	303	366	355	6.5	3.2	1.6	0.43	1.57	2.34	1.53	80
285.750	380.898	244.475	244.475	3.2	1.6	2 280	5 650	LM654648D/610/610D	1	303	367	356	6.5	3.2	1.6	0.43	1.57	2.34	1.53	75.6
288.925	406.400	298.450	298.450	3.2	3.2	3 450	8 840	M255449D/410/410D	1	316	392	373	9	3.2	3.2	0.34	2.00	2.97	1.95	127

[Notes] 1) While metric series bearings have minus tolerances for bore and OD, inch series have plus tolerances. Refer to page C 82 for details of applicable tolerance standards.

2) r_b indicates the shaft chamfer dimension corresponding to cone chamfer dimension r_1 .

Four-row tapered roller bearings

d 292.100 ~ (320) mm

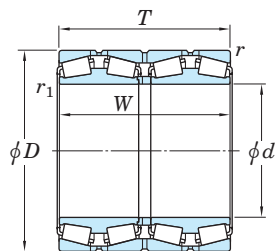

Design 1

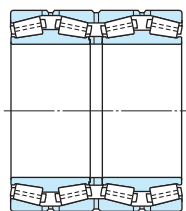

Design 1-P

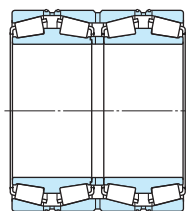

Design 2

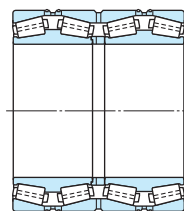

Design 2-P

For oil mist lubrication

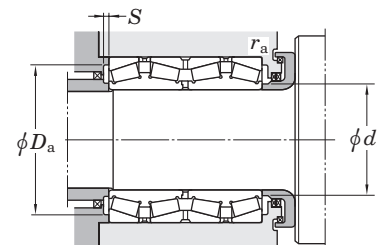

Boundary dimensions (mm)						Basic load ratings (kN)		Bearing No. ²⁾	Design	Mounting dimensions (mm)						Constant e	Axial load factors			(Refer.) Mass (kg)
d	D	T	W	r min.	r ₁ ¹⁾ min.	C _r	C _{0r}			d _a max.	D _a max.	S min.	r _a max.	r _b ³⁾ max.	Y ₂		Y ₃	Y ₀		
292.100	422.275	269.875	269.875	3.2	6.4	3 170	6 830	EE330116D/166/167D	1	321	407	387	7.5	3.2	6.4	0.32	2.11	3.14	2.06	124
300	420	310	310	3	1	3 390	8 050	47T604231	1	325	406	388	8.5	2.5	1	0.34	2.00	2.98	1.96	132
	424	310	310	4	5	3 000	6 570	37260	1	334	406	391	6	3	4	0.28	2.37	3.53	2.32	134
	430	300	300	3	4	3 320	7 630	47T604330	1	328	416	393	10	2.5	3	0.35	1.95	2.90	1.91	141
	430	310	310	3	2.5	3 520	8 420	47T604331	1	332	416	399	10	2.5	2	0.40	1.68	2.50	1.64	146
	460	248	248	4	1.5	3 060	6 300	47T604625	1	342	442	416	8.5	3	1.5	0.40	1.68	2.50	1.64	149
	460	360	360	4	5	4 300	9 550	47T604636	1	339	442	416	9	3	4	0.33	2.03	3.02	1.98	220
	470	270	270	4	5	3 500	6 440	47T604727A	1	338	452	426	8	3	4	0.40	1.68	2.50	1.64	165
	470	292	292	4	SP	3 980	7 870	47T604729B	1-P	341	452	428	8.5	3	2	0.40	1.68	2.50	1.64	193
	470	292	292	4	1.5	4 120	8 210	47T604729C	1-P	343	452	428	9.5	3	1.5	0.33	2.03	3.02	1.98	198
500	350	350	4	2.5	5 010	9 290	47T605035	1	346	482	451	8	3	2	0.40	1.68	2.50	1.64	270	
300.038	422.275	311.150	311.150	3.2	3.2	3 390	8 050	HM256849D/810/810D	1	325	407	388	7	3.2	3.2	0.34	2.00	2.98	1.96	136
304.648	438.048	279.400	280.990	4.8	3.2	3 230	6 980	47T614428C	2	331	420	403	7	4.8	3.2	0.47	1.44	2.15	1.41	133
	438.048	279.400	280.990	4.8	3.2	3 230	6 980	M757448D/410/410D	1	331	420	403	7	4.8	3.2	0.47	1.44	2.15	1.41	132
304.800	419.100	269.875	269.875	6.4	1.6	2 840	6 950	M257149D/110/110D	1	331	398	387	7	6.4	1.6	0.33	2.03	3.02	1.98	110
	482.600	377.825	365.125	6.4	3.2	4 820	9 800	47T614838A	1-P	343	461	437	1	6.4	3.2	0.47	1.43	2.12	1.40	250
	495.300	349.250	342.900	6.4	3.2	4 370	9 370	EE724121D/195/196D	1	355	474	438	7	6.4	3.2	0.40	1.68	2.50	1.64	267
304.902	412.648	266.7	266.7	3.2	3.2	2 990	7 280	M257248D/210/210D	1	328	398	383	7	3.2	3.2	0.32	2.12	3.15	2.07	101
310	430	310	310	3	3	3 520	8 420	47T624331A	1	332	416	399	10	2.5	2.5	0.40	1.68	2.50	1.64	135
	460	325	325	4	5	4 200	9 500	47T6246A	1	346	442	421	12	3	4	0.32	2.12	3.15	2.07	188
317.500	422.275	269.875	269.875	3.2	1.6	2 930	7 450	LM258649D/610/610D	1	341	407	392	8.5	3.2	1.6	0.32	2.12	3.15	2.07	104
	447.675	327.025	327.025	6.4	1.6	4 120	9 820	47T644533J	1-P	341	426	411	7.5	6.4	1.6	0.33	2.02	3.00	1.97	161
	447.675	327.025	327.025	6.4	1.6	4 280	10 100	47T644533L	1	344	426	411	11.5	6.4	1.6	0.33	2.03	3.02	1.98	161
320	440	335	335	2	2.5	3 590	8 750	47T644434	1	341	430	408	5.5	2	2	0.40	1.68	2.50	1.64	149

[Notes] 1) SP indicates the specially chamfered form.
 2) While metric series bearings have minus tolerances for bore and OD, inch series have plus tolerances. Refer to page C 82 for details of applicable tolerance standards.

3) r_b indicates the shaft chamfer dimension corresponding to cone chamfer dimension r₁.

Four-row tapered roller bearings

d (320) ~ (355.600) mm

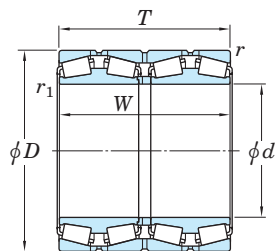

Design 1

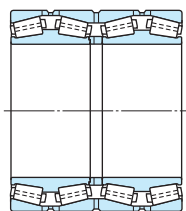

Design 1-P

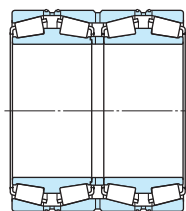

Design 2

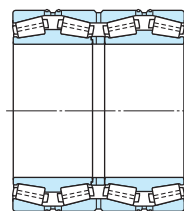

Design 2-P

For oil mist lubrication

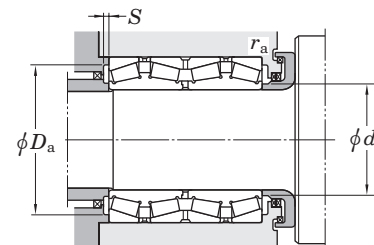

Boundary dimensions (mm)						Basic load ratings (kN)		Bearing No. ¹⁾	Design	Mounting dimensions (mm)						Constant e	Axial load factors			(Refer.) Mass (kg)
d	D	T	W	r min.	r_1 min.	C_r	C_{0r}			d_a max.	D_a max.	D_a min.	S min.	r_a max.	r_b ²⁾ max.		Y_2	Y_3	Y_0	
320	460	325	325	4	2.5	4 030	9 420	47T644633	1	349	442	424	10	3	2.5	0.42	1.62	2.42	1.59	175
	460	338	338	4	5	3 500	8 590	37264	1	356	442	421	8.5	3	4	0.33	2.03	3.02	1.98	183
	480	254	254	4	2.5	3 400	6 940	47T644825	1-P	358	462	437	9	3	2	0.40	1.68	2.50	1.64	161
	480	260	260	4	5	3 360	6 890	47T644826	1	359	462	437	11.5	3	5	0.40	1.68	2.50	1.64	165
	480	360	360	4	1	4 970	11 000	47T644836-1	1-P	352	462	442	9	3	1	0.47	1.43	2.12	1.40	229
	500	380	380	4	1.5	5 540	11 900	47T645038	1-P	363	482	454	11.5	3	1.5	0.33	2.03	3.02	1.98	284
	540	364	364	5	6	5 380	10 600	47364	1	376	518	479	8.5	4	5	0.32	2.12	3.15	2.07	340
325	430	230	230	3	1	2 410	5 800	47T654323	1	347	416	401	8.5	2.5	1	0.40	1.68	2.50	1.64	88.5
327	445	230	230	3	1	2 620	6 080	47T654523	1	353	431	413	9	2.5	1	0.40	1.68	2.50	1.64	102
330.200	444.500	301.625	301.625	3.2	3.2	3 550	9 260	47T664430	1	357	430	414	10	3.2	3.2	0.26	2.55	3.80	2.50	134
	508.000	307.975	307.975	6.4	1.6	4 320	8 500	47T665131A	1	372	486	462	8	6.4	1.6	0.33	2.03	3.02	1.98	219
335.000	460.000	342.900	342.900	3.2	1.6	3 960	9 390	47T674634/DP	2	361	445	428	7.5	3.2	1.6	0.40	1.68	2.50	1.64	165
337.375	469.900	342.900	342.900	3.2	1.6	4 630	11 400	HM261049D/010/010D	1-P	360	455	432	9	3.2	1.6	0.33	2.02	3.01	1.97	190
340	480	350	350	5	6	4 700	11 700	37268A	1-P	371	458	443	9.5	4	6	0.33	2.03	3.02	1.98	198
	520	278	278	5	6	4 040	8 110	47T685228	1	384	498	473	9	4	6	0.40	1.68	2.50	1.64	212
	520	323	323	5	6	4 380	8 930	47T685232	1	381	498	473	10	4	5	0.40	1.68	2.50	1.64	242
343.052	457.098	254.000	254.000	3.2	1.6	2 850	6 950	47T694625	1	363	442	425	6	3.2	1.6	0.47	1.43	2.12	1.40	111
	457.098	254.000	254.000	3.2	1.6	2 850	6 950	47T694625/DP3	2	363	442	425	6	3.2	1.6	0.47	1.43	2.12	1.40	111
346.075	488.950	358.775	358.775	3.2	3.2	4 620	11 600	HM262749D/10/10D	1	378	474	449	8	3.2	3.2	0.33	2.02	3.00	1.97	214
347.663	469.900	292.100	292.100	3.2	3.2	3 600	9 040	M262449D/10/10D	1	374	455	436	10	3.2	3.2	0.33	2.03	3.02	1.98	145
355	490	316	316	2	2.5	4 160	10 000	47T714932	1	385	480	455	12.5	2	2	0.33	2.03	3.02	1.98	180
355.600	482.600	269.875	265.113	3.2	1.6	3 390	7 860	47T714827-1	1	386	468	450	8	3.2	1.6	0.26	2.55	3.80	2.50	139
	482.600	269.875	265.112	3.2	1.6	3 060	7 020	LM763449D/410/410D	1	381	468	450	3.5	3.2	1.6	0.47	1.43	2.14	1.40	136

[Notes] 1) While metric series bearings have minus tolerances for bore and OD, inch series have plus tolerances. Refer to page C 82 for details of applicable tolerance standards.

2) r_b indicates the shaft chamfer dimension corresponding to cone chamfer dimension r_1 .

Four-row tapered roller bearings

d (355.600) ~ (380) mm

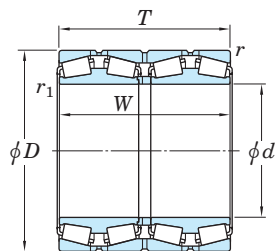

Design 1

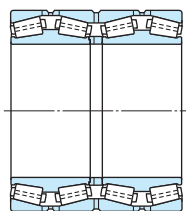

Design 1-P

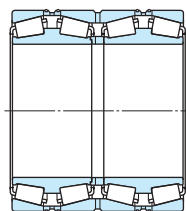

Design 2

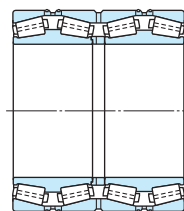

Design 2-P

For oil mist lubrication

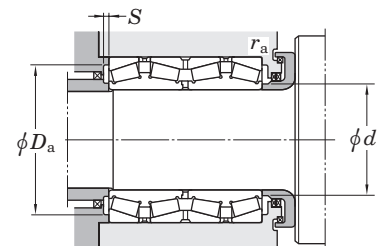

Boundary dimensions (mm)						Basic load ratings (kN)		Bearing No. ¹⁾	Design	Mounting dimensions (mm)						Constant e	Axial load factors			(Refer.) Mass (kg)
d	D	T	W	r min.	r_1 min.	C_r	C_{0r}			d_a max.	D_a max.	D_a min.	S min.	r_a max.	r_b ²⁾ max.		Y_2	Y_3	Y_0	
355.600	488.950	317.500	317.500	3.2	1.6	4 370	10 900	M263349D/310/310D	1-P	383	474	452	7.5	3.2	1.6	0.33	2.03	3.02	1.98	182
360	480	375	375	3	4	3 930	9 910	47T724838A	1	383	466	446	3.5	2.5	3	0.40	1.68	2.50	1.64	177
	480	375	375	3	1	4 190	11 100	47T724838C	1	381	466	448	5	2.5	1	0.33	2.03	3.02	1.98	183
	508	370	370	5	6	4 840	11 500	47T725137	1	392	486	471	7	4	6	0.33	2.03	3.02	1.98	232
	520	370	370	5	6	4 920	11 400	47T725237	1	395	498	476	8.5	4	5	0.33	2.03	3.02	1.98	259
	520	410	410	5	6	5 970	14 300	47T725241	1-P	395	498	479	8.5	4	5	0.33	2.03	3.02	1.98	292
	540	280	280	5	6	3 790	7 820	47272	1	406	518	490	10	4	5	0.32	2.12	3.15	2.07	221
	540	280	280	5	6	3 760	8 000	47T725428	1	402	518	489	10.5	4	5	0.55	1.24	1.84	1.21	224
	540	460	460	4	5	6 440	15 800	47T7254	1	408	522	492	9.5	3	4	0.27	2.47	3.67	2.41	373
368.300	523.875	382.588	382.588	6.4	3.2	5 530	13 600	47T745238B	1-P	404	502	483	9	6.4	3.2	0.29	2.32	3.45	2.26	269
	523.875	382.588	382.588	3.2	1.6	5 620	14 100	47T745238D	1	403	508	483	7.5	3.2	1.6	0.33	2.03	3.02	1.98	265
	523.875	382.588	382.588	6.4	3.2	5 920	14 500	47T745238J	1-P	401	502	485	10.5	6.4	3.2	0.33	2.03	3.02	1.98	268
	523.875	382.588	382.588	6.4	3.2	5 460	13 600	HM265049D/010/010D	1-P	403	502	483	7	6.4	3.2	0.33	2.03	3.02	1.98	269
	563.000	382.588	382.588	6.4	3.2	6 300	13 600	47T745638	1-P	417	541	516	10.5	6.4	3.2	0.29	2.32	3.45	2.26	344
370	516	346	346	4	1.5	4 880	11 700	47T745235	1-P	398	498	479	9	3	1.5	0.40	1.68	2.50	1.64	216
374.650	501.650	260.350	260.350	3.2	1.6	2 930	7 750	47T745026	1	399	486	459	7	3.2	1.6	0.43	1.56	2.32	1.52	145
380	520	360	360	5	6	4 610	12 200	47T765236	1	417	498	484	11	4	5	0.32	2.12	3.15	2.07	225
	520	400	400	4	2.5	5 020	13 000	47T765240	1	404	502	482	9.5	3	2	0.40	1.68	2.50	1.64	248
	536	390	390	5	6	5 760	12 900	37276	1	415	514	496	7.5	4	5	0.40	1.68	2.50	1.64	268
	560	282	282	5	6	3 670	7 580	47276	1	429	538	511	9	4	5	0.27	2.47	3.67	2.41	232
	560	285	285	4	5	4 600	10 000	47T765629	1-P	428	542	513	11	3	4	0.27	2.47	3.67	2.41	246
	560	285	285	4	5	4 420	9 240	47T765629A	1	427	542	515	11	3	5	0.27	2.47	3.67	2.41	244
	560	325	325	5	6	5 330	11 900	47T765633A	1-P	427	538	514	11	4	5	0.27	2.47	3.67	2.41	278
	560	360	390	4	1.5	5 310	11 800	47T765639	1	422	542	514	9	3	1.5	0.35	1.95	2.90	1.91	307
	560	370	370	5	6	5 910	13 600	47T765637	1-P	423	538	515	10	4	5	0.33	2.03	3.02	1.98	312
	580	500	500	5	6	7 410	17 500	47T765850	1	427	558	529	10.5	4	5	0.33	2.03	3.02	1.98	478

[Notes] 1) While metric series bearings have minus tolerances for bore and OD, inch series have plus tolerances. Refer to page C 82 for details of applicable tolerance standards.

2) r_b indicates the shaft chamfer dimension corresponding to cone chamfer dimension r_1 .

Four-row tapered roller bearings

d (380) ~ 430 mm

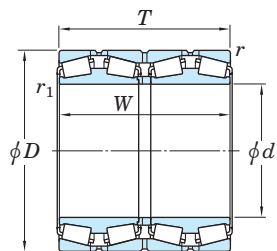

Design 1

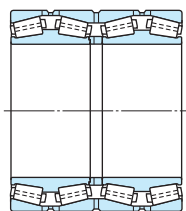

Design 1-P

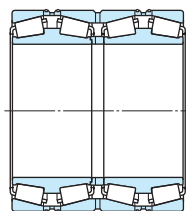

Design 2

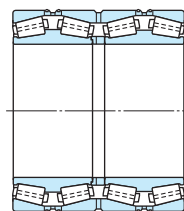

Design 2-P

For oil mist lubrication

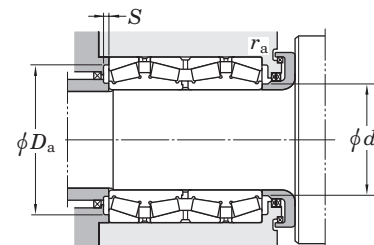

Boundary dimensions (mm)						Basic load ratings (kN)		Bearing No. ¹⁾	Design	Mounting dimensions (mm)						Constant e	Axial load factors			(Refer.) Mass (kg)
d	D	T	W	r min.	r_1 min.	C_r	C_{0r}			d_a max.	D_a max.	S min.	r_a max.	r_b ²⁾ max.	Y_2		Y_3	Y_0		
380	620	400	400	5	6	6 130	12 700	47376 47T766242	1 1-P	445	598	552	6.5	4	5	0.32	2.12	3.15	2.07	476
	620	418.5	418.5	5	6	7 080	14 000			435	598	561	10	4	5	0.46	1.47	2.19	1.44	499
384.175	546.100	400.050	400.050	6.4	3.2	6 530	16 900	HM266449D/410/410D 47T775547	1-P 1	418	524	502	10.5	6.4	3.2	0.33	2.03	3.02	1.98	315
	546.100	470.000	470.000	6.4	3.2	6 220	16 200			418	524	503	7.5	6.4	3.2	0.33	2.03	3.02	1.98	360
390	510	350	350	3	1.5	4 300	11 700	47T785135A 47T785135B	1 1	413	496	478	10.5	2.5	1.5	0.33	2.03	3.02	1.98	186
	510	350	350	3	1	4 150	11 200			415	496	479	5.5	2.5	1	0.29	2.32	3.45	2.26	183
395	545	288.7	270.3	7.5	5	3 330	7 680	47T795529	1	433	509	494	3	6	4	0.43	1.57	2.34	1.53	190
400	560	380	380	4	1.5	5 970	15 200	47T805638A 47T805641 47T805930A 47280	1-P 1-P 1-P 1	435	542	519	10	3	1.5	0.33	2.03	3.02	1.98	296
	564	412	412	4	2.5	6 470	16 500			432	546	522	9	3	2.5	0.40	1.68	2.50	1.64	329
	590	304	304	4	1.5	4 760	10 200			449	572	540	7.5	3	1.5	0.33	2.03	3.02	1.98	289
	600	308	308	5	6	4 810	9 930			452	578	548	9	4	5	0.33	2.03	3.02	1.98	310
406.400	546.100	288.925	288.925	6.4	1.6	3 960	9 540	47T815529 47T815533B 47T815638 M267949D/910/910XD	1 1-P 1 1	435	524	509	9.5	6.4	1.6	0.47	1.43	2.12	1.40	184
	546.100	330.000	330.000	6.4	3.2	4 800	12 400			434	524	509	8.5	6.4	3.2	0.40	1.68	2.50	1.64	214
	562.000	381.000	381.000	6.4	3.2	5 990	15 000			439	540	524	9.5	6.4	3.2	0.33	2.03	3.02	1.98	284
	565.150	381.000	381.000	6.4	3.2	5 990	15 000			438.3	544	524	9.5	6.4	3.2	0.33	2.03	3.02	1.98	291
409.575	546.100	334.963	334.963	6.4	1.6	4 570	11 500	M667947D/911/911D	1	432	524	509	8.5	6.4	1.6	0.42	1.62	2.42	1.59	213
415.925	590.550	434.975	434.975	6.4	3.2	7 060	18 800	47T835943A	1-P	455	568	543	10	6.4	3.2	0.33	2.03	3.02	1.98	391
420	560	370	370	5	6	4 950	13 600	47T845637 47T845644 37284 47284 47T846546	1 1 1 1 1	459	538	527	12	4	5	0.32	2.12	3.15	2.07	252
	560	437	437	4	1.5	5 620	14 900			450	542	526	4	3	1.5	0.26	2.55	3.80	2.50	283
	592	432	432	5	6	6 030	15 700			460	570	544	7.5	4	5	0.33	2.03	3.02	1.98	374
	620	312	312	5	6	4 810	10 400			473.5	598	567	10	4	5	0.33	2.03	3.02	1.98	328
	650	460	460	6	6	8 560	18 300			468	622	595	8.5	5	5	0.40	1.68	2.50	1.64	558
430	570	336	336	4	1.5	4 790	12 500	47T865734C 47T865738	1 1	460	552	536	10	3	1.5	0.36	1.87	2.79	1.83	232
	570	380	380	4	1.5	5 640	15 900			463	552	534	10.5	3	1.5	0.26	2.55	3.80	2.50	269

[Notes] 1) While metric series bearings have minus tolerances for bore and OD, inch series have plus tolerances. Refer to page C 82 for details of applicable tolerance standards.

2) r_b indicates the shaft chamfer dimension corresponding to cone chamfer dimension r_1 .

Four-row tapered roller bearings

d 431.800 ~ 475.000 mm

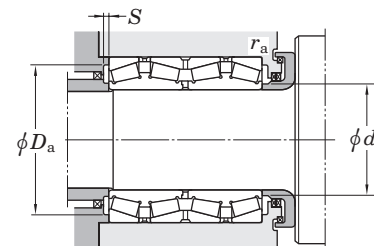
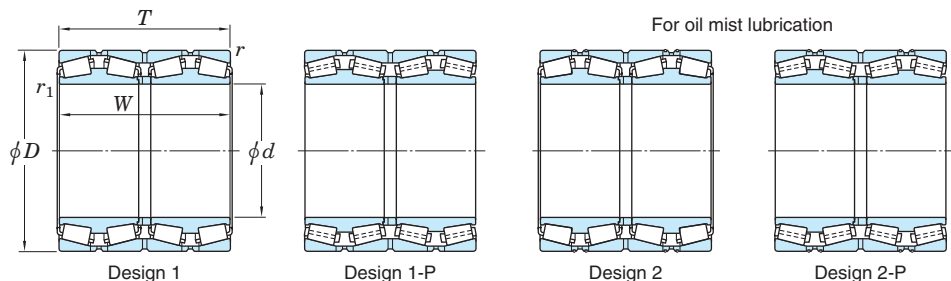

Boundary dimensions (mm)						Basic load ratings (kN)		Bearing No. ¹⁾	Design	Mounting dimensions (mm)						Constant e	Axial load factors			(Refer.) Mass (kg)
d	D	T	W	r min.	r_1 min.	C_r	C_{0r}			d_a max.	D_a max.	D_a min.	S min.	r_a max.	r_b ²⁾ max.		Y_2	Y_3	Y_0	
431.800	571.500	336.550	336.550	6.4	1.6	5 070	13 500	47T865734	1-P	460	549	534	10	6.4	1.6	0.36	1.87	2.79	1.83	232
	571.500	336.550	336.550	6.4	1.6	4 290	11 300	LM769349D/310/310D	1	463	549	534	7	6.4	1.6	0.48	1.41	2.10	1.38	231
	635.000	355.600	355.600	6.4	6.4	6 310	13 700	EE931170D/250/251XD	1-P	481	612	586	8	6.4	6.4	0.32	2.10	3.13	2.06	385
432.003	609.524	317.500	317.500	6.4	3.6	5 210	12 100	EE736173D/238/239D	1-P	474	586	562	9	6.4	3.6	0.35	1.94	2.89	1.90	291
440	580	420	420	4	1.5	5 730	15 400	47T885842	1-P	467	562	544	1.5	3	1.5	0.26	2.55	3.80	2.50	288
	620	454	454	6	6	7 110	17 500	37288	1	482	592	576	9	5	5	0.40	1.68	2.50	1.64	417
	620	454	454	4	5	7 610	19 800	47T886246	1-P	474	602	573	10.5	3	5	0.40	1.68	2.50	1.64	436
	635	430	430	5	6	7 560	18 000	47T886443	1-P	485	613	587	9.5	4	5	0.33	2.03	3.02	1.98	450
	635	470	470	5	2.5	8 510	20 900	47T886447	1-P	483	613	588	10.5	4	2	0.33	2.03	3.02	1.98	500
	650	326	326	6	6	5 080	11 000	47288	1-P	500	622	595	11	5	5	0.28	2.43	3.61	2.37	361
	650	334	334	6	6	5 490	12 200	47288A	1	500	622	595	9.5	5	5	0.28	2.43	3.61	2.37	375
	660	450	450	5	2	8 690	19 000	47T886645	1	489	638	610	9.5	4	2	0.32	2.12	3.15	2.07	532
447.675	635.000	463.550	463.550	6.4	3.2	7 860	21 000	M270749D/710/710D	1-P	491	612	584	8	6.4	3.2	0.33	2.03	3.02	1.98	472
449.949	594.949	368.000	368.000	5	2.5	5 980	16 200	M270449D/10/10D	1-P	478	573	557	9	5	2	0.33	2.03	3.02	1.98	278
450	580	450	450	6	1.5	5 130	14 600	47T905845	1	475	552	537	2	5	1.5	0.26	2.55	3.80	2.50	286
457.200	596.900	279.400	276.225	3.2	1.6	4 260	11 400	47T916028A	1-P	485	581	560	8.5	3.2	1.6	0.47	1.43	2.12	1.40	307
	660.400	323.847	323.850	6.4	3.2	5 700	12 700	EE737179D/260/261D	1-P	501	637	603	9	6.4	3.2	0.37	1.80	2.69	1.76	365
460	586	280	280	3	1	3 710	9 810	47T925928	1	483	572	555	10.5	2.5	1	0.44	1.52	2.26	1.49	177
	615	360	360	3	1	5 000	13 300	47T926236	1	490	601	572	8	2.5	1	0.47	1.43	2.12	1.40	292
	625	421	421	4	1.5	6 920	18 800	47T926342	1-P	495	607	582	8	3	1.5	0.33	2.03	3.02	1.98	386
	650	474	474	6	6	7 680	19 400	37292	1	500	622	598	8	5	5	0.33	2.03	3.02	1.98	495
	680	375	375	5	2	6 500	15 200	47T926838	1	515	658	618	10.5	4	2	0.36	1.87	2.79	1.83	475
	730	440	440	6	3	8 650	17 700	47T927344	1-P	519	702	662	13	5	2.5	0.47	1.43	2.12	1.40	710
475.000	600.000	368.000	368.000	4.8	1.6	4 970	15 100	47T956037A	1	501	581	566	10.5	4.8	1.6	0.26	2.55	3.80	2.50	246

[Notes] 1) While metric series bearings have minus tolerances for bore and OD, inch series have plus tolerances. Refer to page C 82 for details of applicable tolerance standards.

2) r_b indicates the shaft chamfer dimension corresponding to cone chamfer dimension r_1 .

Four-row tapered roller bearings

d 479.425 ~ 500 mm

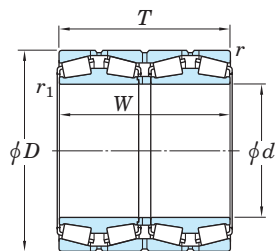

Design 1

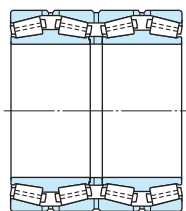

Design 1-P

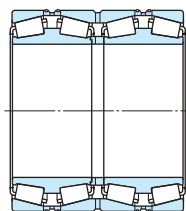

Design 2

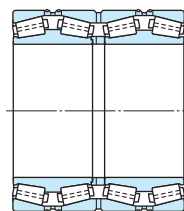

Design 2-P

For oil mist lubrication

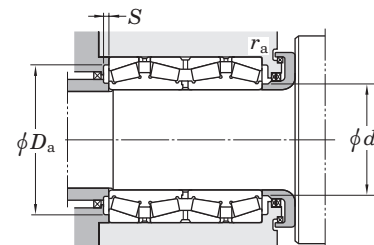

Boundary dimensions (mm)						Basic load ratings (kN)		Bearing No. ²⁾	Design	Mounting dimensions (mm)						Constant e	Axial load factors			(Refer.) Mass (kg)
d	D	T	W	r min.	$r_1^{1)}$ min.	C_r	C_{0r}			d_a max.	D_a max.	S min.	r_a max.	$r_b^{3)}$ max.	Y_2		Y_3	Y_0		
479.425	679.450	495.300	495.300	6.4	3.2	9 660	25 400	47T966850 M272749D/710/710D	1-P	523	656	641	12.5	6.4	3.2	0.33	2.03	3.02	1.98	591
	679.450	495.300	495.300	6.4	3.2	8 480	22 200			1-P	524	656	627	7.5	6.4	3.2	0.33	2.03	3.02	1.98
480	678	494	494	6	6	9 160	23 300	37296 47T967039	1-P	520	650	629	9.5	5	5	0.33	2.03	3.02	1.98	563
	700	390	390	5	6	7 400	16 800			1-P	536	678	647	11	4	6	0.33	2.03	3.02	1.98
480.000	700.000	420.000	420.000	6.4	3.2	8 060	18 800	47T967042C	1	531	677	644	10.5	6.4	3.2	0.35	1.95	2.90	1.91	540
482.600	615.950	330.200	330.200	6.4	6.4	4 830	13 400	47T976233 4TR19A 4TR19B 4TR19D 47T976242 47T976542A M272647D/610/610D	2-P	512	593	573	6	6.4	6.4	0.44	1.54	2.30	1.51	240
	615.950	330.200	330.200	6.4	6.4	4 830	13 400			1-P	512	593	573	6.5	6.4	6.4	0.44	1.54	2.30	1.51
	615.950	330.200	330.200	6.4	4.8	5 270	15 000		1-P	509	593	573	10.5	6.4	4.8	0.33	2.03	3.02	1.98	243
	615.950	330.200	330.200	6.4	3.2	5 210	15 000		1	508	593	573	10	6.4	3.2	0.36	1.87	2.79	1.83	240
	615.950	420.000	420.000	4	2.5	5 810	16 700		1	508	597	577	6	4	2.5	0.26	2.55	3.80	2.50	296
	647.700	417.512	417.512	6.4	3.2	7 390	20 300		2-P	514	624	603	9.5	6.4	3.2	0.33	2.03	3.02	1.98	397
	647.700	417.512	417.512	6.4	3.2	7 390	20 300		1-P	514	624	604	9.5	6.4	3.2	0.33	2.03	3.02	1.98	395
	488.950	622.300	365.125	365.125	3.6	3.6	4 950		13 900	47T986236 EE640193D/260/261D	1	516	605	585	7.5	3.6	3.6	0.33	2.03	3.02
660.400		361.950	365.125	6.4	7.9	6 200	15 800	1-P	527			637	616	11	6.4	7.9	0.31	2.20	3.27	2.15
489.026	634.873	320.675	320.675	3.2	3.2	4 520	13 200	EE243193D/250/251D LM772749D/710/710D	1	526	618	595	9.5	3.2	3.2	0.34	1.97	2.93	1.93	263
	634.873	320.675	320.675	3.2	3.2	4 930	13 700			1	513	618	594	9.5	3.2	3.2	0.47	1.43	2.12	1.40
490	625	385	385	4	1.5	5 690	17 200	47T986339A 47T986339B	1	520	607	587	9.5	3	1.5	0.28	2.43	3.61	2.37	290
	625	385	385	4	1.5	5 540	16 600			1	517	607	587	4.5	3	1.5	0.32	2.12	3.15	2.07
500	640	450	450	4	1.5	7 050	20 300	4TR500M 4TR500B 372/500 4TR500T 4TR500J 4TR500Q	2-P	527	622	602	10.5	3	1.5	0.24	2.84	4.23	2.78	352
	670	515	515	5	6	9 110	25 700			1-P	530	648	626	11	4	5	0.32	2.12	3.15	2.07
	705	515	515	6	SP	9 530	24 500		1-P	544	677	651	8.5	5	6	0.37	1.80	2.69	1.76	641
	710	430	425	5	3	8 170	20 000		1	547	688	658	12	4	3	0.37	1.80	2.69	1.76	528
	720	400	400	6	6	7 990	18 700		1-P	552	692	663	12.5	5	5	0.33	2.03	3.02	1.98	547
	760	420	420	2	6	8 730	19 300		1-P	566	750	696	11.5	2	6	0.39	1.74	2.59	1.70	698

[Notes] 1) SP indicates the specially chamfered form.
2) While metric series bearings have minus tolerances for bore and OD, inch series have plus tolerances. Refer to page C 82 for details of applicable tolerance standards.

3) r_b indicates the shaft chamfer dimension corresponding to cone chamfer dimension r_1 .

Sealed type four-row tapered roller bearings

d 75 ~ 234.950 mm

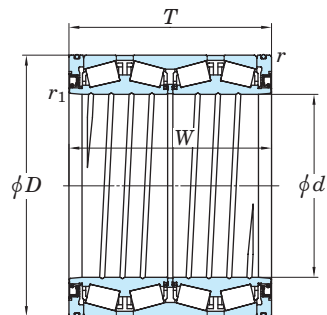

Design 1

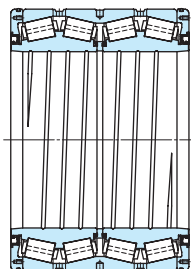

Design 1-P

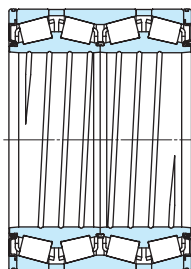

Design 2

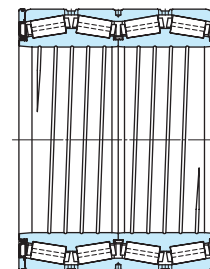

Design 2-P

Boundary dimensions								Basic load ratings (kN)		Bearing No.	Design	Constant e	Axial load factors		(Refer.) Mass (kg)		
d	D		T		W		r ¹⁾	r ₁ ¹⁾	C _r				C _{0r}	Y ₂		Y ₃	
mm	1/25.4	mm	1/25.4	mm	1/25.4	mm	1/25.4	min.	min.								
75	—	120	—	150	—	150	—	2	1	424	764	47TS151215	1	0.33	2.03	3.02	6.4
	—	135	—	180	—	187	—	1.5	1.5	455	776		47TS151418	1	0.87	0.78	1.16
140	—	198	—	174	—	174	—	4	1	803	1 630	47TS282017	1	0.47	1.43	2.12	16.3
150	—	210	—	240	—	240	—	1.5	0.5	993	2 270	47TS302124	1	0.39	1.74	2.59	23.5
170	—	240	—	175	—	175	—	2.5	1.5	980	1 990	47TS342418	1	0.26	2.55	3.8	23.9
	—	250	—	230	—	230	—	2.5	1.5	1 370	2 860		47TS342523	1	0.26	2.55	3.8
190.500	7.5000	266.700	10.5000	188.913	7.4375	187.325	7.3750	3.2	1	1 060	2 270	47TS382719A	1	0.46	1.47	2.19	27.6
195	—	270	—	250	—	250	—	2.5	1	1 420	3 550	47TS392725-1	1	0.4	1.68	2.5	43.6
200	—	300	—	300	—	300	—	4	1.6	2 260	4 900	47TS403030	1	0.26	2.55	3.8	73.5
203.200	8.0000	317.500	12.5000	266.700	10.5000	266.700	10.5000	5	1.6	2 060	4 010	47TS413227	1	0.4	1.68	2.5	76.8
206.375	8.1250	282.575	11.1250	190.500	7.5000	190.500	7.5000	3.2	1	1 100	2 240	47TS412819	1	0.51	1.33	1.97	33.5
	8.1250	282.575	11.1250	240.000	9.4488	210.000	8.2677	3	1	1 450	3 380		47TS412824	1	0.43	1.57	2.34
215.900	8.5000	288.925	11.3750	177.800	7.0000	177.800	7.0000	3.2	1	1 060	2 350	47TS432918	1	0.4	1.68	2.5	30.6
220	—	295	—	315	—	315	—	SP	SP	1 540	3 910	47TS443032A	1	0.4	1.68	2.5	55.8
	—	320	—	290	—	290	—	3	2	2 200	4 700	47TS443229B	1	0.39	1.74	2.59	73.9
	—	330	—	260	—	260	—	5	2.5	2 100	4 220	47TS443326	1	0.4	1.68	2.5	79.5
220.663	8.6875	314.325	12.3750	239.713	9.4375	239.713	9.4375	3.2	3	1 680	3 410	47TS443124	1	0.33	2.03	3.02	51.9
	8.6875	314.325	12.3750	330.000	12.9921	330.000	12.9921	3.2	3	2 360	5 650		47TS443133	1	0.26	2.55	3.8
225	—	320	—	230	—	230	—	3	1.5	1 630	3 350	47TS453223A	1	0.47	1.43	2.12	56.9
228.600	9.0000	311.150	12.2500	200.025	7.8750	200.025	7.8750	3.2	SP	1 330	2 850	47TS463120-1	1	0.4	1.68	2.5	41.3
234.950	9.2500	327.025	12.8750	196.850	7.7500	196.850	7.7500	3.2	1	1 490	3 310	47TS473320A	2	0.4	1.68	2.5	48.1

[Note] 1) SP indicates the specially chamfered form.

Sealed type four-row tapered roller bearings

d 240 ~ (280) mm

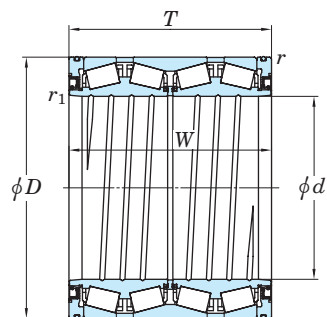

Design 1

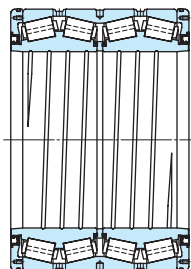

Design 1-P

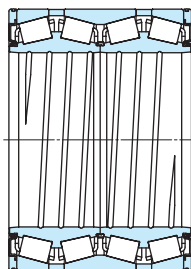

Design 2

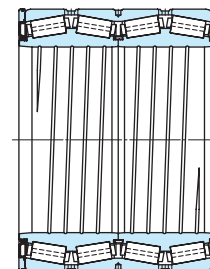

Design 2-P

Boundary dimensions								Basic load ratings (kN)		Bearing No.	Design	Constant e	Axial load factors		(Refer.) Mass (kg)		
d	D		T		W		r	r ₁ ¹⁾	C _r				C _{0r}	Y ₂		Y ₃	
mm	1/25.4	mm	1/25.4	mm	1/25.4	mm	1/25.4	mm	min.	min.							
240	—	320	—	294	—	294	—	4	1	1 880	4 760	47TS483229-1 47TS483425B 47TS483429 47TS483432 47TS483434A	1	0.33	2.03	3.02	63.6
	—	338	—	248	—	248	—	3	1.5	1 890	4 120		1	0.47	1.43	2.12	66
	—	338	—	290	—	290	—	3	1	2 360	5 360		1	0.39	1.74	2.59	78
	—	338	—	320	—	320	—	3	1	2 430	5 890		1	0.28	2.43	3.61	87.3
	—	338	—	340	—	340	—	3	1	2 450	5 930		1	0.4	1.68	2.5	88
241.478	9.5070	349.148	13.7460	228.600	9.0000	228.600	9.0000	3.2	SP	2 000	4 110	47TS483523A	2	0.35	1.91	2.84	67.5
244.475	9.6250	327.025	12.8750	193.675	7.6250	193.675	7.6250	5	1.5	1 280	2 790	47TS493319 47TS493830	1	0.33	2.03	3.02	41.5
	9.6250	381.000	15.0000	304.800	12.0000	304.800	12.0000	5	1.6	2 700	5 240		1	0.47	1.43	2.12	124
245	—	345	—	310	—	310	—	3	1.5	2 520	6 020	47TS493531-2	1	0.4	1.68	2.5	89.9
250	—	365	—	270	—	270	—	3	1.5	2 260	4 730	47TS503727A-1	1	0.4	1.68	2.5	94.2
254.000	10.0000	358.775	14.1250	269.875	10.6250	269.875	10.6250	3.2	1.6	2 130	4 760	47TS513627A-1 47TS513627B	1	0.55	1.24	1.84	82
	10.0000	358.775	14.1250	269.875	10.6250	269.875	10.6250	3.2	1.5	2 520	6 010		2	0.4	1.68	2.5	85
260	—	365	—	340	—	340	—	3.5	1.6	2 800	6 530	47TS523734-5 47TS523735	1	0.4	1.68	2.5	110
	—	370	—	354	—	354	—	4	1.5	3 100	7 410		1	0.26	2.55	3.8	120
266.700	10.5000	355.600	14.0000	228.600	9.0000	230.188	9.0625	3.2	1.6	1 940	4 880	47TS533623B	2	0.36	1.87	2.79	60
275	—	385	—	340	—	340	—	3	1.5	2 970	7 400	47TS553934	1	0.4	1.68	2.5	121
276.225	10.8750	393.700	15.5000	269.875	10.6250	269.875	10.6250	3.2	1.6	2 350	5 040	47TS553927-4 47TS553927A	1	0.47	1.43	2.12	100
	10.8750	393.700	15.5000	269.875	10.6250	269.875	10.6250	3.2	SP	2 770	6 510		2	0.4	1.68	2.5	105
279.400	11.0000	393.700	15.5000	269.875	10.6250	269.875	10.6250	3.2	1.6	2 350	5 040	47TS563927 47TS563927B 47TS563932-2	1	0.47	1.43	2.12	99.5
	11.0000	393.700	15.5000	269.875	10.6250	269.875	10.6250	3.2	SP	2 770	6 510		2	0.4	1.68	2.5	101
	11.0000	393.700	15.5000	320.000	12.5984	320.000	12.5984	3.2	1.5	2 880	6 900		1	0.4	1.68	2.5	124
279.578	11.0070	380.898	14.9960	244.475	9.6250	244.475	9.6250	3.2	SP	2 270	5 360	47TS563824	2	0.4	1.68	2.5	78.3
280	—	380	—	290	—	290	—	3.2	SP	2 720	6 940	47TS563829A	2	0.33	2.03	3.02	93.8

[Note] 1) SP indicates the specially chamfered form.

Sealed type four-row tapered roller bearings

d (280) ~ 317.500 mm

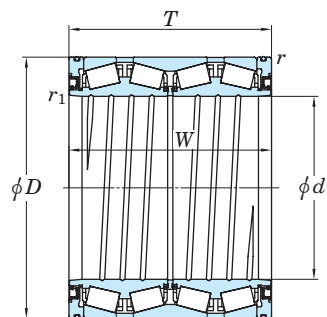

Design 1

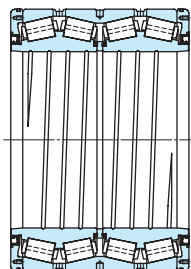

Design 1-P

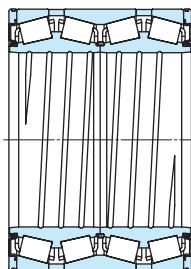

Design 2

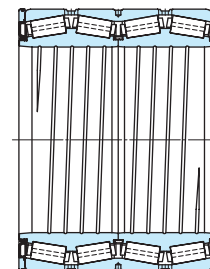

Design 2-P

Boundary dimensions								Basic load ratings (kN)		Bearing No.	Design	Constant e	Axial load factors		(Refer.) Mass (kg)			
d mm	D mm	T mm	W mm	r min.	r_1 ¹⁾ min.	C_r	C_{Or}	Y_2	Y_3									
280	—	395	—	290	—	290	—	3	2.5	2 640	5 940	47TS564029	1	0.4	1.68	2.5	110	
	—	395	—	340	—	340	—	3	1.5	2 960	7 110		47TS564034A	1	0.4	1.68	2.5	130
	—	410	—	268	—	268	—	5.4	1.6	2 240	4 510		47TS564127	1	0.33	2.03	3.02	118
	—	412	—	340	—	340	—	4	2	3 350	7 220		47TS564134	1	0.28	2.43	3.61	154
	—	430	—	350	—	350	—	3.5	1.5	3 940	8 190		47TS564335	1	0.4	1.68	2.5	178
285	—	400	—	340	—	340	—	3	1.5	3 190	7 610	47TS574034	1	0.4	1.68	2.5	131	
285.750	11.2500	380.898	14.9960	244.475	9.6250	244.475	9.6250	3.2	1	2 000	4 600	47TS573824A	1	0.43	1.57	2.34	73.2	
290	—	400	—	346	—	346	—	4	1.5	3 070	7 860	47TS584035	1	0.4	1.68	2.5	128	
	—	400	—	420	—	420	—	4	1.5	3 070	7 860		47TS584042C	1	0.4	1.68	2.5	155
	—	420	—	380	—	380	—	3	1.2	3 640	8 260		47TS584238	1	0.4	1.68	2.5	175
	—	450	—	415	—	415	—	4	1.5	4 460	9 460		47TS584542	1	0.47	1.43	2.12	238
300	—	400	—	254	—	254	—	4	5	2 220	5 300	47TS604025	1	0.28	2.43	3.61	84.6	
	—	420	—	310	—	310	—	4	3.5	2 890	6 670		47TS604231	1	0.4	1.68	2.5	128
304.648	11.9940	438.048	17.2460	279.400	11.0000	280.990	11.0626	4	1.6	2 570	5 380	47TS614428B-10	1	0.47	1.44	2.15	135	
	11.9940	438.048	17.2460	279.400	11.0000	279.400	11.0000	3.2	1.6	3 140	6 860		47TS614428C-1	2	0.4	1.68	2.5	135
304.800	12.0000	419.100	16.5000	269.875	10.6250	269.875	10.6250	6.4	2	2 490	5 420	47TS614227	1	0.33	2.03	3.02	100	
	12.0000	501.650	19.7500	336.550	13.2500	296.550	11.6752	4	4	4 280	8 570		47TS615034	1-P	0.33	2.03	3.02	257
304.902	12.0040	412.648	16.2460	266.700	10.5000	266.700	10.5000	3.2	0.8	2 750	6 820	47TS614127D	2	0.39	1.74	2.59	99.5	
310	—	430	—	310	—	310	—	3	1	3 010	6 880	47TS624331-4	1	0.4	1.68	2.5	131	
	—	430	—	350	—	350	—	3.5	1.5	3 280	7 870		47TS624335A	1	0.4	1.68	2.5	148
	—	430	—	350	—	350	—	3.5	SP	3 280	7 870		47TS624335B-2	1	0.4	1.68	2.5	148
	—	457.098	—	390	—	390	—	4	1.5	4 200	9 500		47TS624639	1	0.32	2.12	3.15	220
317.500	12.5000	447.675	17.6250	367.000	14.4488	367.000	14.4488	4	1.6	3 680	8 500	47TS644537-1	1	0.4	1.68	2.5	176	

[Note] 1) SP indicates the specially chamfered form.

Sealed type four-row tapered roller bearings

d 320 ~ 410 mm

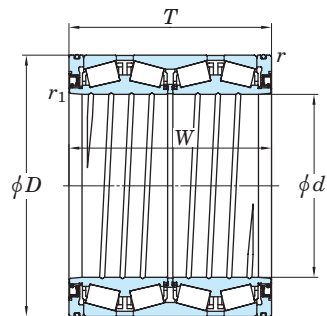

Design 1

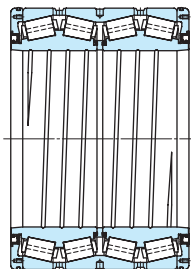

Design 1-P

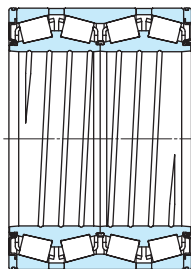

Design 2

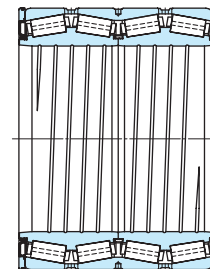

Design 2-P

Boundary dimensions								Basic load ratings (kN)		Bearing No.	Design	Constant e	Axial load factors		(Refer.) Mass (kg)	
d	D	T	W	r ¹⁾	r ₁ ¹⁾	C _r	C _{0r}	Y ₂	Y ₃							
mm	mm	mm	mm	min.	min.											
320	—	440	—	335	—	335	—	4	1	3 140	7 330	1	0.4	1.68	2.5	146
	—	480	—	360	—	360	—	4	1.5	4 210	8 800	1-P	0.47	1.43	2.12	220
	—	480	—	420	—	420	—	4	1.5	5 470	12 100	1-P	0.26	2.55	3.8	262
330.302	13.0040	438.023	17.2450	254.000	10.0000	247.650	9.7500	3.2	1.6	2 190	4 960	1	0.46	1.47	2.19	95.8
335.000	13.1890	460.000	18.1102	342.900	13.5000	342.900	13.5000	3.3	1.5	3 740	9 290	1	0.4	1.68	2.5	167
342.875	13.4990	488.900	19.2480	410.000	16.1417	410.000	16.1417	4	2	4 620	11 600	1	0.33	2.02	3	233
342.875	—	560	—	500	—	500	—	5	2.5	7 210	15 000	1-P	0.33	2.03	3.02	495
343.052	13.5060	457.098	17.9960	254.000	10.0000	254.000	10.0000	3.2	0.8	2 870	7 030	2	0.4	1.68	2.5	110
	13.5060	457.098	17.9960	299.000	11.7717	299.000	11.7717	3.2	SP	3 310	9 010	2	0.4	1.68	2.5	135
346.075	13.6250	488.950	19.2500	358.775	14.1250	358.775	14.1250	4	2	3 780	8 310	1	0.33	2.03	3.02	210
350	—	480	—	420	—	420	—	SP	1.5	3 700	9 100	1-P	0.4	1.68	2.5	217
355	—	490	—	316	—	316	—	2	1.6	3 540	7 920	1	0.33	2.03	3.02	169
355.600	14.0000	482.600	19.0000	269.875	10.6250	265.112	10.4375	3.2	1.5	2 680	6 090	1-P	0.47	1.43	2.12	134
360	—	480	—	375	—	375	—	3	1	4 120	10 600	1	0.4	1.68	2.5	181
374.650	14.7500	501.650	19.7500	260.350	10.2500	250.825	9.8750	3.2	1.6	3 120	7 470	2	0.33	2.03	3.02	136
380	—	580	—	370	—	370	—	3	SP	5 690	12 300	1-P	0.33	2.03	3.02	353
395	—	545	—	360	—	360	—	6	1.6	3 790	8 930	1	0.47	1.43	2.12	242
406.400	16.0000	546.100	21.5000	288.925	11.3750	288.925	11.3750	6.4	1	3 620	8 190	2-P	0.47	1.43	2.12	195
	16.0000	546.100	21.5000	330.000	12.9921	330.000	12.9921	4	1.5	4 310	10 500	2-P	0.43	1.57	2.34	204
	16.0000	546.100	21.5000	357.400	14.0709	357.400	14.0709	3.2	1.6	3 960	9 540	1	0.47	1.43	2.12	220
410	—	546	—	400	—	400	—	4	1.5	4 630	12 000	1	0.26	2.55	3.8	255

[Note] 1) SP indicates the specially chamfered form.

Sealed type four-row tapered roller bearings

d 415.925 ~ 482.600 mm

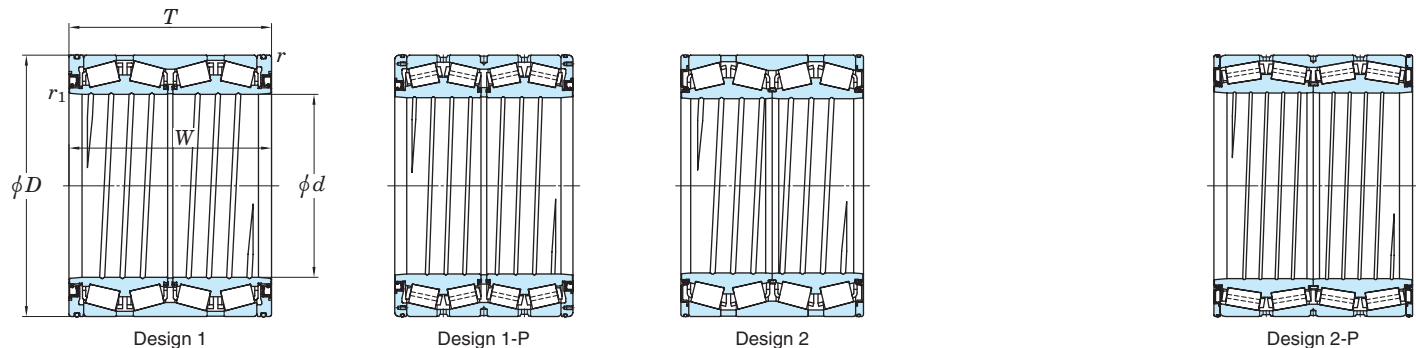

Boundary dimensions								Basic load ratings (kN)		Bearing No.	Design	Constant e	Axial load factors		(Refer.) Mass (kg)
d	D	T	W	r ¹⁾	r ₁ ¹⁾	C _r	C _{0r}	Y ₂	Y ₃						
mm	mm	mm	mm	min.	min.										
415.925	590.550	434.975	434.975	4	1.5	6 390	15 600	47TS835944A	2-P	0.4	1.68	2.5	377		
420	560	437	437	4	3	5 620	14 900	47TS845644	1	0.26	2.55	3.8	298		
	574	480	480	3	1.6	6 730	17 800	47TS845748	1-P	0.28	2.43	3.61	352		
	620	395	320	SP	SP	5 160	11 600	47TS846240	1-P	0.47	1.43	2.12	390		
430	575	380	380	3.2	SP	5 200	14 300	47TS865838A	2-P	0.26	2.55	3.8	276		
431.800	571.500	336.550	336.550	3.2	1.5	4 440	11 600	47TS865734A	2	0.4	1.68	2.5	229		
440	590	480	480	4	SP	6 870	18 700	47TS885948A-3	2-P	0.26	2.55	3.8	362		
	620	454	454	4	1.5	6 580	16 100	47TS886245-1	1-P	0.33	2.03	3.02	430		
	635	470	413	5	2	6 870	15 700	47TS886447	1	0.33	2.03	3.02	461		
450	595	420	420	5	1.5	6 110	16 300	47TS906042	1-P	0.26	2.55	3.8	308		
457.200	596.900	279.400	276.225	3.2	1.6	3 760	9 520	47TS916028C	2-P	0.47	1.43	2.12	191		
	596.900	279.400	276.225	3.2	1.6	3 300	8 180	47TS916028D	2-P	0.7	0.97	1.44	187		
460	620	470	470	4	1.5	7 060	19 300	47TS926247	1-P	0.26	2.55	3.8	412		
479.425	679.450	495.300	495.300	6.4	2	8 030	19 600	47TS966850	1-P	0.33	2.03	3.02	562		
480.000	647.700	417.512	417.512	6.4	SP	6 680	17 400	47TS966542	1-P	0.33	2.03	3.02	391		
480	700	470	470	5	1.5	8 080	18 800	47TS967047	1-P	0.32	2.12	3.15	621		
482.600	615.950	330.200	330.200	6.4	1.6	4 310	11 700	4TRS19B	1-P	0.44	1.54	2.3	240		
	615.950	330.200	330.200	3.2	1.6	4 360	11 800	4TRS19C	2	0.4	1.68	2.5	229		
	615.950	330.200	330.200	3.2	1.6	4 510	12 400	4TRS19D	2-P	0.4	1.68	2.5	239		
	615.950	385.000	385.000	6.4	1.6	5 270	15 000	47TS976239	1-P	0.33	2.03	3.02	278		
	615.950	420.000	420.000	6.4	1.6	5 090	14 500	47TS976242	1	0.33	2.03	3.02	302		
	615.950	425.000	425.000	6.4	1.6	5 090	14 500	47TS976243	1	0.33	2.03	3.02	306		
	647.700	417.512	417.512	6.4	1.6	6 680	17 400	47TS976542A	1-P	0.33	2.03	3.02	382		

[Note] 1) SP indicates the specially chamfered form.

Sealed type four-row tapered roller bearings

d 488.950 ~ 800 mm

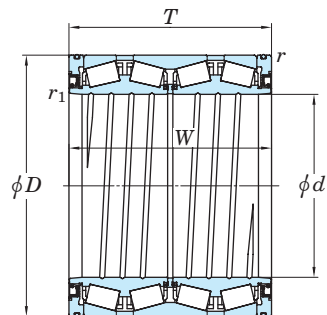

Design 1

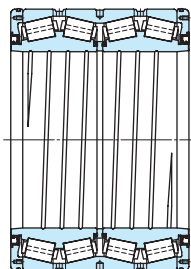

Design 1-P

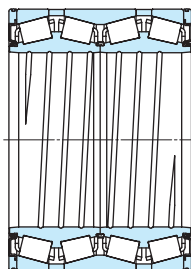

Design 2

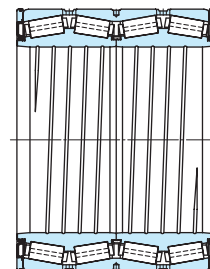

Design 2-P

Boundary dimensions										Basic load ratings (kN)		Bearing No.	Design	Con- stant e	Axial load factors		(Refer.) Mass (kg)
d mm	D mm	T mm	W mm	r min.	$r_1^{1)}$ min.	C_r	C_{Or}	Y_2	Y_3								
488.950	19.2500	622.300	24.5000	365.125	14.3750	365.125	14.3750	6.4	1.5	4 320	12 200	47TS986236	1	0.4	1.68	2.5	270
492	—	655	—	480	—	480	—	5	1.5	7 450	21 200	47TS986648	1-P	0.33	2.03	3.02	449
509.948	20.0767	654.924	25.7844	379.000	14.9213	377.000	14.8425	6.4	1.5	5 370	15 200	4TRS510B	1-P	0.41	1.64	2.44	320
530	—	715	—	590	—	590	—	5	1.5	10 300	28 900	4TRS530A	1-P	0.26	2.55	3.8	664
558.800	22.0000	736.600	29.0000	372.263	14.6560	372.263	14.6560	7	SP	6 910	16 100	4TRS559J	1-P	0.34	1.97	2.93	425
	22.0000	736.600	29.0000	409.575	16.1250	409.575	16.1250	6	1.5	6 850	18 600	4TRS559C	1-P	0.35	1.95	2.9	475
	22.0000	736.600	29.0000	450.000	17.7165	450.000	17.7165	6	1.5	7 180	19 700	4TRS559A	1-P	0.35	1.95	2.9	507
	22.0000	736.600	29.0000	480.000	18.8976	480.000	18.8976	6	1.5	7 960	22 700	4TRS559B	1-P	0.4	1.68	2.5	547
	22.0000	736.600	29.0000	500.000	19.6850	500.000	19.6850	6	1.6	8 220	23 100	4TRS559	1-P	0.35	1.95	2.9	560
585.788	23.0625	771.525	30.3750	479.425	18.8750	479.425	18.8750	6.4	1.5	8 730	24 400	4TRS586A	1-P	0.33	2.03	3.02	613
595.312	23.4375	844.550	33.2500	615.950	24.2500	615.950	24.2500	6.4	3.6	12 700	32 200	4TRS595B	1-P	0.33	2.03	3.02	1 120
600	—	870	—	700	—	700	—	5	4	15 100	39 400	4TRS600A	1-P	0.33	2.03	3.02	1 370
609.600	24.0000	787.400	31.0000	361.950	14.2500	361.950	14.2500	6.4	3.2	5 920	14 900	4TRS610	1-P	0.4	1.68	2.5	430
	24.0000	813.562	32.0300	540.000	21.2598	540.000	21.2598	6.4	1.5	10 200	28 500	4TRS610A	1-P	0.33	2.03	3.02	775
679.450	26.7500	901.700	35.5000	552.450	21.7500	552.450	21.7500	6.4	3	11 100	30 600	4TRS679	1-P	0.33	2.03	3.02	951
685.800	27.0000	876.300	34.5000	355.600	14.0000	352.425	13.8750	6.4	3.2	6 130	16 300	4TRS686A	1-P	0.42	1.62	2.42	520
704.850	27.7500	914.400	36.0000	552.450	21.7500	552.450	21.7500	6.4	3.2	11 300	33 400	4TRS705	1-P	0.33	2.03	3.02	940
711.200	28.0000	914.400	36.0000	317.500	12.5000	317.500	12.5000	3.2	SP	6 070	16 700	4TRS711N	2-P	0.46	1.47	2.19	507
	28.0000	914.400	36.0000	387.350	15.2500	387.350	15.2500	6.4	3.2	7 160	19 400	4TRS711A	1-P	0.38	1.78	2.65	615
	28.0000	914.400	36.0000	410.000	16.1417	410.000	16.1417	6.4	3.2	7 610	20 500	4TRS711	1-P	0.44	1.54	2.29	670
	28.0000	914.400	36.0000	420.000	16.5354	420.000	16.5354	6.4	3.2	7 870	22 200	4TRS711L	1-P	0.4	1.68	2.5	678
800	—	1 130	—	780	—	780	—	6	1.5	21 900	58 800	4TRS800	1-P	0.26	2.55	3.8	2 520

[Note] 1) SP indicates the specially chamfered form.

Bearings for railway rolling stock axle journals

Bearings used to support rolling stock axle journals are required to be very strong and, at the same time, to be small because of limited space.

Double-row bearings that are larger in width than general bearings are popular in that they are compact and have high load ratings.

■ Cylindrical roller bearings

- Feature good high-speed performance, and can be maintained and inspected easily because of their separable structure.

Most commonly used bearing.

- Those with a rib next to the inner ring are able to support not only radial load but also a certain degree of axial load, so that a ball bearing is not required to accommodate the axial load.

■ Sealed type cylindrical roller bearing units and tapered roller bearing units

- Maintenance-free : pre-lubricated with grease and provided with oil seals.
- Can be used with a simplified axle box, or with an adapter instead.
- The inch series axle bearing units (ABU) are as specified in the "association of american rail-roads".

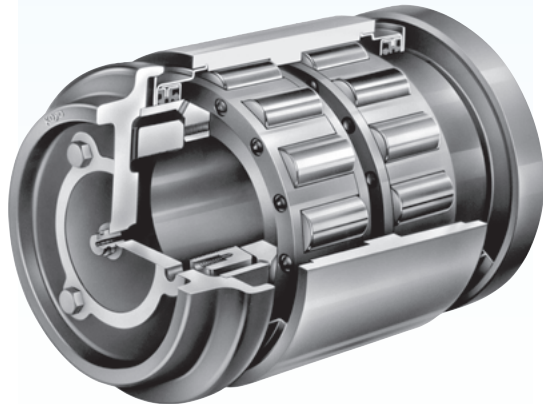

Cylindrical roller bearings

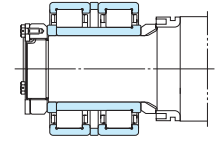

Bore diameter **85 – 133 mm**

Sealed type cylindrical roller bearing units

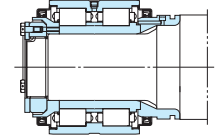

Bore diameter **95 – 120 mm**

Sealed type tapered roller bearing units(ABU)

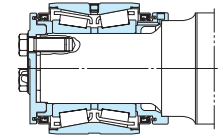

Bore diameter **101.600 – 177.787 mm**

Tolerances	<ul style="list-style-type: none"> Cylindrical roller and axial load support ball bearings : as specified in JIS B 1514-1, class 0 (Table 7-3 on pp. A 54–A 57). (The tolerances for cylindrical roller bearing width and overall width are as shown in Table 1.) Metric series ABU bearings: refer to Table 2. Inch series ABU bearings : refer to Table 3.
Recommended fits	Refer to Table 4.
Radial internal clearance	<ul style="list-style-type: none"> Cylindrical roller bearings : class C 3 UIC* standard cylindrical roller bearings : class C 4 (refer to Table 10-8 on p. A 100.) Axial load support ball bearings : class C 5 However, the clearance class should be adjusted according to the axle box structure. Consult with JTEKT for further information. ABU bearings : class C 3 (refer to Table 10-10 on p. A 104) *Denotes that the bearings are compatible with axle journals and axle boxes standardized by the UIC.

Table 1 Cylindrical roller bearings for axle journals : tolerances for inner ring width, outer ring width and overall width

(1) Tolerances for inner ring width and inner ring overall width Unit : μm

Bearing type	Design	Nominal bore diameter d (mm)		ΔB_s Or ΔB_{1s}	
		over	up to	upper	lower
Inner ring one-piece type, Inner ring with a rib and loose rib	1-1, 1-2 2-1, 2-3	80	120	0	-400
		120	180	0	-500
Two inner rings and spacer	2-2	80	120	0	-600
		120	180	0	-700

(2) Tolerances for outer ring width and outer ring overall width Unit : μm

Bearing type	Design	Nominal bore diameter d (mm)		ΔC_s Or ΔC_{1s}	
		over	up to	upper	lower
Outer ring one-piece type	2-3	80	120	0	-300
		120	180	0	-350
Outer ring and two loose ribs	1-1	80	120	+100	-200
		120	180	+100	-250
Two outer rings	2-1 ¹⁾	120	180	0	-500
Two outer rings and spacer	1-2 2-1, 2-2	80	120	0	-500
		120	180	0	-600

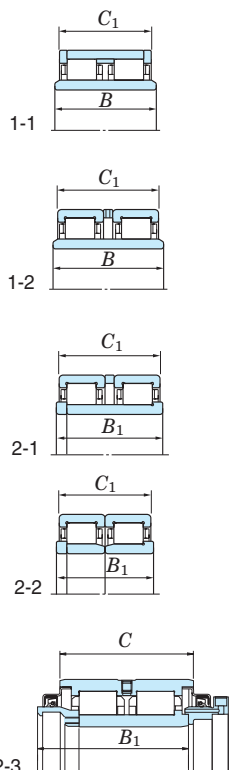

[Note] 1) (2-1) means that spacer shown in Design 2-1 is removed.

Table 2 Metric series ABU bearing tolerances Unit : μm

Nominal bore diameter d (mm)	Single plane mean bore diameter deviation Δd_{mp}		Single plane mean outside diameter deviation ΔD_{mp}		Single outer ring width deviation ΔC_s		Actual overall width of inner rings deviation ΔB_{1s}	
	upper	lower	upper	lower	upper	lower	upper	lower
110	0	-20			+50	-50		
120	0	-20	0	-125	+100	-100	+500	-500
130	0	-25			+100	-100		

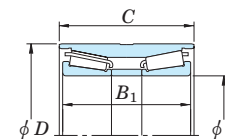

Table 3 Inch series ABU bearing tolerances Unit : μm

Nominal bore diameter d (mm)	Single plane mean bore diameter deviation Δd_{mp}		Single plane mean outside diameter deviation ΔD_{mp}		Single outer ring width deviation ΔC_s		Actual overall width of inner rings deviation ΔB_{1s}	
	upper	lower	upper	lower	upper	lower	upper	lower
101.6 to 177.8	+25	0	+127	0	+50	-250	+710	-510

Table 4 Axle journal bearing recommended fits

Bearing type	Axle journal diameter (mm)		Axle journal tolerance class	Axle box bore tolerance class
	over	up to		
Cylindrical roller bearing Tapered roller bearing	50	100	(m 6), n 6	H 7
	100	140	n 6	
	140	240	p 6	
Axial load support deep groove ball bearing	All diameters		k 5	Clearance fit (clearance of approx. 0.2 to 0.6 mm)

Cylindrical roller bearings
for railway rolling stock axle journals

d 85 ~ (120) mm

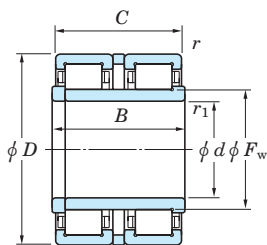

Design 1

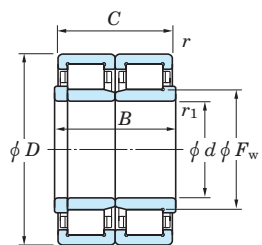

Design 2

d	Boundary dimensions (mm)						Basic load ratings (kN)		Bearing No. ²⁾	Design ³⁾	(Refer.) Mass (kg)
	D	B	C	F_w	$r_{min.}$	$r_1^{1)}$	C_r	C_{Or}			
85	150	130	120	101.5	1.1	(7)	369	592	2U2217SC	3	8.6
90	160	88	80	107	2	2	355	529	2CR90D	1	7.2
95	170	120	105	114	1.1	(10)	497	804	2UJ95	4	10.9
	170	125	115	113.5	2.5	(7)	441	687	2CR95A	1	11.5
	170	130	130	114	2	2	441	688	2UJ1917	3	11.4
	170	140	125	114	1.1	(10)	555	926	4UJ95	5	12.7
100	180	150	134	120	1.1	(10)	594	990	4UJ100	5	15.1
	190	140	130	122	2.5	(7)	697	1 120	20DC19130/140	3	16.9
	200	170	170	125	2	(7)	755	1 160	2CR100	1	23.7
	200	170	170	125	2	(10)	755	1 160	20DC20170	3	23.2
110	200	180	160	134	1.1	(7)	721	1 190	JC3	5	22.6
	220	180	160	138	2.5	(7)	789	1 190	JC6	1	30.0
	220	185	180	138	2	(7)	922	1 460	2CR110	1	31.3
	225	150	140	138	1.1	(7)	833	1 230	JC1A	4	27.7
	225	150	140	138	2.5	(7)	897	1 350	22DC23140/150	3	26.7
	235	180	160	141	2.5	(7)	934	1 430	JC2A	3	35.3
116	220	185	180	142	2	(7)	891	1 470	2CR116	1	30.5
	225	150	140	197.5	1.1	(7)	786	1 220	2UJ116	4	26.0
120	225	170	165	145	3	(10)	876	1 380	JC35	1	29.4
	230	170	165	145	3	(10)	943	1 460	JC34	1	30.8
	230	177	150	145	3	(30)	943	1 460	JC27X	(1)	29.7
	240	160	160	150	3	7.5	961	1 500	(24NJ/NJP2480)	2	33.9
	240	180	160	150	1.1	(10)	1 020	1 580	JC11	4	35.5
	240	180	176	150	3	(7)	1 020	1 580	JC12	1	37.7

[Notes] 1) Values in () indicate axial chamfer dimension.
2) Bearings indicated in () are in accordance with UIC standards.
3) (1) means that the inner ring (rib side) shown in Design 1 has a special form.
(2) means that loose rib shown in Design 2 is replaced with thrust collar.

d (120) ~ 133 mm

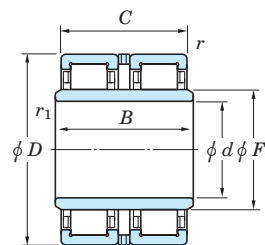

Design 3

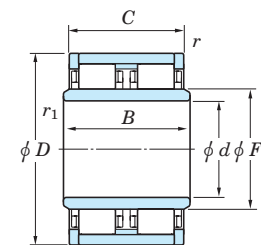

Design 4

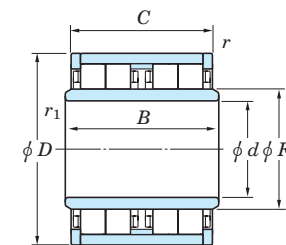

Design 5

d	Boundary dimensions (mm)						Basic load ratings (kN)		Bearing No. ²⁾	Design ³⁾	(Refer.) Mass (kg)
	D	B	C	F_w	$r_{min.}$	$r_1^{1)}$	C_r	C_{Or}			
120	240	185	180	150	2	(7)	983	1 600	2CR120A	1	37.8
130	220	170	160	152	1.1	0.6	865	1 520	4UJ130B	5	25.2
	240	160	160	157	3	5	867	1 390	(2CR2624A)	2	32.0
	240	180	160	158	1.1	(10)	970	1 610	4UJ130A	5	35.8
	240	204	198	157	3	5	867	1 390	(2CR2624)	2	35.4
	250	160	160	158	3	7.5	1 090	1 720	(26NJ/NJP2580)	2	36.4
	260	180	160	163	1.1	(10)	1 080	1 710	JC5	4	42.7
	260	185	180	163	3	(7)	1 030	1 610	2CR130A	1	44.2
	260	186	172	164	3	7.5	1 220	1 930	26NJ/NUJ2686	(2)	44.6
	260	205.5	180	163	3	(30)	1 030	1 610	JC21	(1)	45.1
	270	215	210	164	4	(15)	1 280	2 000	JC29	3	55.1
280	215	210	167	4	(15)	1 440	2 250	JC9-1	3	61.4	
133	280	215	210	167	4	(15)	1 440	2 250	JC9-2	3	59.8

Sealed type cylindrical roller bearings for railway rolling stock axle journals

d 95 ~ 120 mm

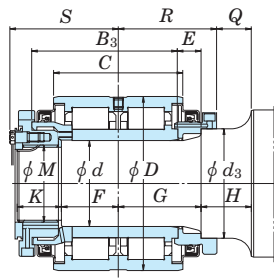

Design 1

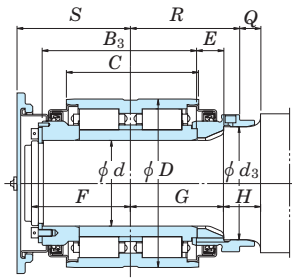

Design 2

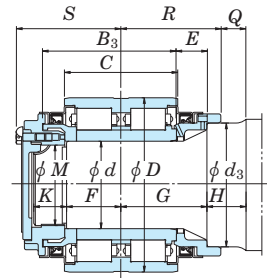

Design 3

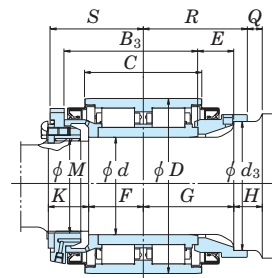

Design 4

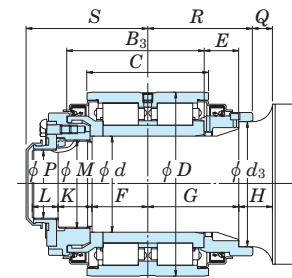

Design 5

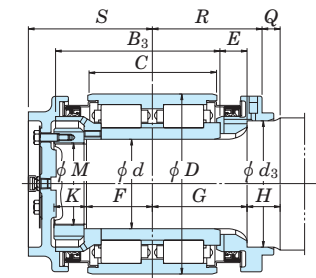

Design 6

Shaft dia. (mm) d	Unit No.	Design	Boundary dimensions (mm)														Basic load ratings (kN) C_r C_{Or}	(Refer.) Unit Mass (kg)				
			$d_{Brg.}$	D	C	B_3	d_3	E	F	G	H	K	L	M	P	Q			R	S	Bearing No.	
95	JB1425	1	95	190	140	158	120	25	62	90	35	48	—	M85×4	—	18	107	119	19RDC19140/158	610	910	24.5
100	JB1199B	2	100	195	150	175	130	30	120	105	42	—	—	—	—	24	123	130	20RDC20150/133B	673	1 040	27.5
110	JB1462	3	110	220	145	171	155	39	70	110	50	42	—	M100×2	—	33	127	134	S-JC33	789	1 190	35.9
120	JB1356	4	120	220	150	170	158	46	70	116	36	51	—	M115×4	—	19	133	131	24RDC22150/170	702	1 110	34.9
	JB1380D	5	120	230	150	171	155	43	70	113	42	42	33	M110×2	85	25	130	152	JC32	831	1 290	39.0
	JB1010	6	120	240	170	218	168	35	87	125	45	43	—	M110×2	—	25	145	164	JC17	1 020	1 580	57.7
	JB1240	7	120	240	160	193	168	31	80	113	38	40	38	M110×2	85	27	128	169	JC26	935	1 420	51.1
	JB1377	8	120	240	160	192	150	30	83	112	40	38	—	M110×4	—	—	135	131	24RDC24160/192A	935	1 420	42.0

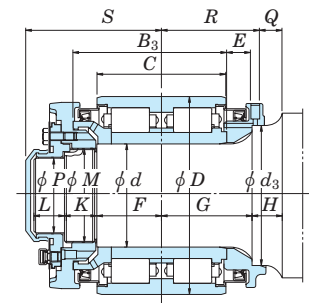

Design 7

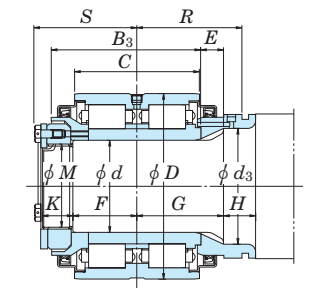

Design 8

Sealed type tapered roller bearings for railway rolling stock axle journals (ABU bearing)

d 101.6 ~ 177.787 mm
110 ~ 130 mm

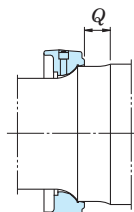
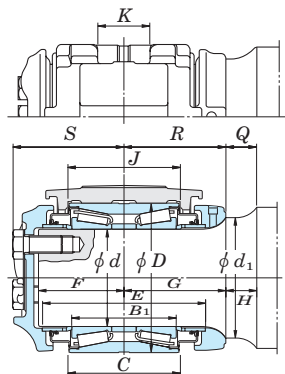
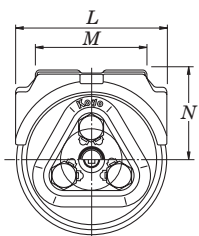

The shape of the backing ring used for JB1204P, JB1205P and JB1206P.

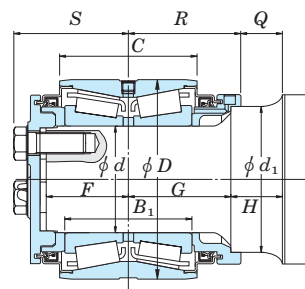

JB1486

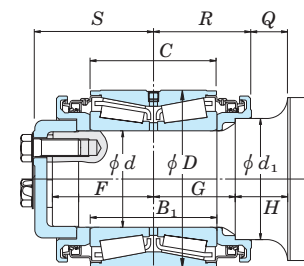

JB1450

Dynamic equivalent load
(when $F_r/F_r \leq e$)
 $P = F_r + Y_2 F_a$
(when $F_r/F_r > e$)
 $P = 0.67 F_r + Y_3 F_a$
Static equivalent load
 $P_0 = F_r + Y_0 F_a$

Class	Axle size	Unit No.	Boundary dimensions (mm)											Adapter No.	Dimensions of adapter (mm)					Bolt size	Dimensions (mm) p	Bearing No.	Basic load ratings (kN)		Constant e	Axial load factors			(Refer.) Mass (kg)			
			Brg. d	Axle ¹⁾ d	D	B ₁	C	d ₁ ¹⁾	E	F	G	H	Q		R	S	J	K	L				M	N		C _r	C _{0r}	Y ₂	Y ₃	Y ₀	Unit	Adapter
B	4 1/4x8	JB1201	101.600	101.702 101.676	165.100	106.362	114.300	127.0	182.6	101.6	117.5	41.3	41.3	117.5	134.8	JB701	117.5	68.3	165.9	124.6	101.6	3/4-10 UNC	61.9	HM120848/ HM120817XD	402	769	0.26	2.55	3.80	2.50	17.3	3.8
C	5 x9	JB1202	119.062	119.164 119.139	195.262	136.525	142.875	149.2	217.5	112.7	134.9	36.5	36.5	134.9	147.0	JB702	146.0	74.6	196.1	143.7	117.5	7/8-9 UNC	76.2	HM124646/ HM124618XD	626	1200	0.26	2.55	3.80	2.50	25.3	6.1
D	5 1/2x10	JB1203	131.750	131.864 131.839	207.962	146.050	152.400	161.9	227.0	115.9	139.7	44.5	44.5	139.7	150.5	JB703	155.6	74.6	208.8	156.4	123.8	7/8-9 UNC	88.9	HM127446/ HM127415XD	641	1270	0.26	2.55	3.80	2.50	28.3	7.4
E	6 x11	JB1204	144.450	144.564 144.539	220.662	155.575	163.512	177.8	241.3	127.0	150.8	46.0	46.0	150.8	164.1	JB704	166.7	96.8	221.5	181.8	136.5	1-8 UNC	98.4	HM129848/ HM129814XD	667	1380	0.26	2.55	3.80	2.50	34.3	10.8
		JB1204P	144.450	144.564 144.539	220.662	155.575	163.512	178.613 178.562	241.3	127.0	150.8	46.0	36.8	160.0	164.1	JB704	166.7	96.8	221.5	181.8	136.5	1-8 UNC	98.4	HM129848/ HM129814XD	667	1380	0.26	2.55	3.80	2.50	35.0	10.8
F	6 1/2x12	JB1205	157.150	157.264 157.239	252.412	177.800	184.150	190.5	273.0	134.9	163.5	46.0	46.0	163.5	176.6	JB705	187.3	96.8	253.2	194.5	152.4	1 1/8-7 UNC	108.0	HM133444/ HM133416XD	910	1890	0.26	2.55	3.80	2.50	51.6	16.3
		JB1205P	157.150	157.264 157.239	252.412	177.800	184.150	191.313 191.262	273.0	134.9	163.5	46.0	36.7	172.8	176.6	JB705	187.3	96.8	253.2	194.5	152.4	1 1/8-7 UNC	108.0	HM133444/ HM133416XD	910	1890	0.26	2.55	3.80	2.50	52.4	16.3
G	7 x12	JB1206P	177.787	177.902 177.876	276.225	180.975	185.738	203.251 203.200	269.9	130.2	150.8	58.7	46.0	163.5	180.1	JB706 ²⁾	189.7	181.0	—	279.4	168.3	1 1/4-7 UNC	117.5	HM136948/ HM136916XD	1080	2220	0.26	2.55	3.80	2.50	59.2	23
—	110	JB558	110	110.076 110.054	175	125	130	155	206	105	135	30	30	135	136.4	JB558	134	70	175	135	110	M22	75	JT9	481	972	0.26	2.55	3.80	2.50	22.0	5.6
—		JB1486	110	110.059 110.037	205	130	140	150.068 150.043	—	85	105	53	43	115	118.4	—	—	—	—	—	—	M22	75	JT13	743	1220	0.26	2.55	3.80	2.50	27.3	—
—	120	JB613	120	120.076 120.054	195	136	142	155	217	113	135	30	30	135	147.5	JB613	146	74.5	196	142.5	118	M22	75	JT10	626	1200	0.26	2.55	3.80	2.50	27.0	6.2
—		JB1450	120	120.059 120.037	220	155	155	150.068 150.043	—	125	100	55	35	120	164.4	—	—	—	—	—	—	M22	75	JT12	907	1670	0.26	2.55	3.80	2.50	36.6	—
—	130	JB633	130	130.076 130.054	208	146	152	165	227	139	139	26	26	139	149.2	JB633 ²⁾	156	110	255	232	130	M22	89	JT11	641	1270	0.26	2.55	3.80	2.50	30.0	14.3

[Notes] 1) Upper figures : max. value ; lower : min.value

2) JB706 and JB633 indicate the specifications of wide adapters. Others indicate narrow adapters (shown in figures above).

Linear ball bearings

Linear ball bearings have an outer cylinder and a cage with three or more elliptic raceways inside. Balls are aligned on these raceways.

Ball complement
bore diameter (mm)
SDM series 6 – 120
SDMF, SDMK series 6 – 80
SDE series 5 – 80

Standard type	Clearance adjustable type	Open type
Suitable for a wide range of applications and widely used in practice. The upper-class type is used for general purposes. The precision-class type is used when the bearing is required to be highly accurate.	The outer cylinder and side plate are slit axially so that the clearance between the bearing and shaft can be adjusted. Together with the use of a boreadjustable housing, a no-clearance state or light-preloaded state can be realized without fitting.	The outer cylinder and side plate each have a slit which is equivalent in size to a recirculating ball row raceway, so that the bearing does not interfere with a shaft strut during operation. This type is suitable for use with very long shafts. The bore diameter is adjustable.

Flanged type



Can be fit quickly, and helps make equipment smaller and lighter in weight. Helps reduce cost.

Sealed type

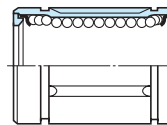

One or both side(s) is/are sealed with special synthetic rubber so that foreign material cannot enter the bearing while the grease is kept from leaking. This sealing can be provided on all bearings of the standard, clearance adjustable, open, and flanged types.



Bearing numbering system

Series code	Ball complement bore diameter number	Seal code	Shape code	Material code	Tolerance code
Series code		SDM : metric series SDMF : metric series (flanged type) SDMK : metric series (flanged type) SDE : metric series (popular ones in europe) SDB : inch series			
Ball complement bore diameter number	Metric series	35 : ball complement bore diameter 35 mm			
	Inch series	4 : ball complement bore diameter 4/16 = 1/4 inch			
Seal code		UU : both sides sealed U : single side sealed Not specified : not sealed			
Shape code		Not specified : standard type AJ : clearance adjustable type OP : open type			
Material code	Outer cylinder and balls	Not specified : high carbon chrome bearing steel			
	Cage	Not specified : cold rolled steel sheet MG : synthetic resin			
Tolerance code		Not specified : upper-class P : precision-class			

■ Linear ball bearing service life

Linear ball bearing service life refers to the distance that the bearing travels until the outer cylinder, balls or shaft become damaged because of rolling contact fatigue from repeated stress.

The basic dynamic load rating refers to the magnitude of a constant load which makes a bearing's service life end after it travels a distance of 50 km.

The linear ball bearing service life and the basic dynamic load rating bear the relation shown below :

$$L = 50 \left(\frac{C}{P} \right)^3$$

where :

- L : service life km
- P : radial load on the bearing N
- C : bearing basic dynamic load rating N (refer to the specification table.)

Shaft surface hardness is closely related to running performance. In general, it is best for the hardness to be 60 thru 64 HRC.

If the hardness is 60 HRC or lower, the basic dynamic load rating (C) should be corrected by multiplying it by the appropriate hardness coefficient selected from Table 1.

Shaft hardness HRC	Hardness coefficient f_H
60	1
59	0.97
57	0.88
55	0.76
53	0.64
51	0.52

● Ball row arrangement and load rating

The basic load ratings given in the specification table are those measured when a load is applied directly above a ball row (Q_1). When the load is applied between two ball rows, the load ratings become larger (Q_2). Table 2 lists the ratios of Q_2 ratings to Q_1 ratings.

Number of ball rows	When a load is applied directly above a row (Q_1)	When a load is applied between two rows (Q_2)	Ratios of Q_2 to Q_1
4			1.414
5			1.463
6			1.280

[Note] When there are only three rows, $Q_2 / Q_1 = 1$

■ Recommended fits for linear ball bearings

Table 3 lists the recommended fits for linear ball bearings.

When a bearing is mounted with a housing, the normal clearance fit should be selected. When the application is highly precise or special, the transition fit should be selected.

For the clearance adjustable and open type bearings, it is best for the shaft diameter to be smaller than the ball complement bore diameter lower deviation, and for the housing bore diameter to be larger than the bearing outside diameter upper deviation.

Bearing	Tolerance	Shaft tolerance class		Housing bore tolerance class	
		Normal clearance	Close clearance	Clearance fit	Transition fit
SDM, SDB	Upper-class	f 6, g 6	h 6	H 7	JS 7 (J 7)
	Precision-class	f 5, g 5	h 5	H 6	JS 6 (J 6)
SDE	-	h 6	js 6 (j 6)	H 7	JS 7 (J 7)

■ Linear ball bearing clearance

Linear ball bearings provide linear motion smoothly with little wear when the clearance is 0.003 to 0.012 mm. However, when clearance increase due to wear is considered critical, e.g. when the bearing is provided to press die sets, precision machine tools or precision testers; when the bearing becomes unable to slide because of moment; or when smooth bearing operation is needed with no clearance provided, the clearance is adjusted to zero or negative.

In such a case, shafts generally need to be mounted by "selective fitting." They should be handled carefully so as not to be preloaded excessively.

As Fig. 1 shows, the clearance of bearings with numbers SDM 6 thru SDM 10 can be easily set to

zero or negative, by adjusting one of the three ball rows with a bolt.

Consult with JTEKT on the gauging of linear ball bearings and shafts which should be mounted by "selective fitting," as well as on the whole design of shafts.

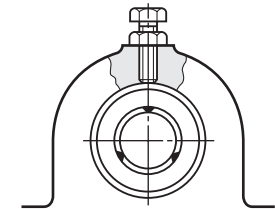

Fig. 1 Clearance adjustment

Table 4 SDM series linear ball bearing tolerances Unit : μm

Bearing number SDM	Ball complement bore diameter (F_w) deviation				Outside diameter (D) deviation		Overall length (L) deviation		B deviation		Eccentricity	
	Precision-class		Upper-class								Precision-class	Upper-class
	upper	lower	upper	lower	upper	lower	upper	lower	max.			
6, 8	0	-6	0	-9	0	-11	0	-200	0	-200	8	12
10, 12, 13, 16	0	-6	0	-9	0	-13	0	-200	0	-200	8	12
20	0	-7	0	-10	0	-16	0	-200	0	-200	10	15
25, 30	0	-7	0	-10	0	-16	0	-300	0	-300	10	15
35, 38, 40, 50	0	-8	0	-12	0	-19	0	-300	0	-300	12	20
60	0	-9	0	-15	0	-22	0	-300	0	-300	17	25
80	0	-9	0	-15	0	-22	0	-400	0	-400	17	25
100, 120	0	-10	0	-20	0	-25	0	-400	0	-400	20	30

Table 5 SDE series linear ball bearing tolerances Unit : μm

Bearing number SDE	Ball complement bore diameter (F_w) deviation		Outside diameter (D) deviation		Overall length (L) deviation		B deviation		Eccentricity max.
	upper	lower	upper	lower	upper	lower	upper	lower	
5, 8	+ 8	0	0	- 8	0	-200	0	-200	12
10, 12	+ 8	0	0	- 9	0	-200	0	-200	12
16	+ 9	-1	0	- 9	0	-200	0	-200	12
20	+ 9	-1	0	-11	0	-200	0	-200	15
25, 30	+11	-1	0	-11	0	-300	0	-300	15
40, 50	+13	-2	0	-13	0	-300	0	-300	17
60	+13	-2	0	-15	0	-400	0	-400	20
80	+16	-4	0	-15	0	-400	0	-400	20

Linear ball bearings

d 5 ~ (20) mm

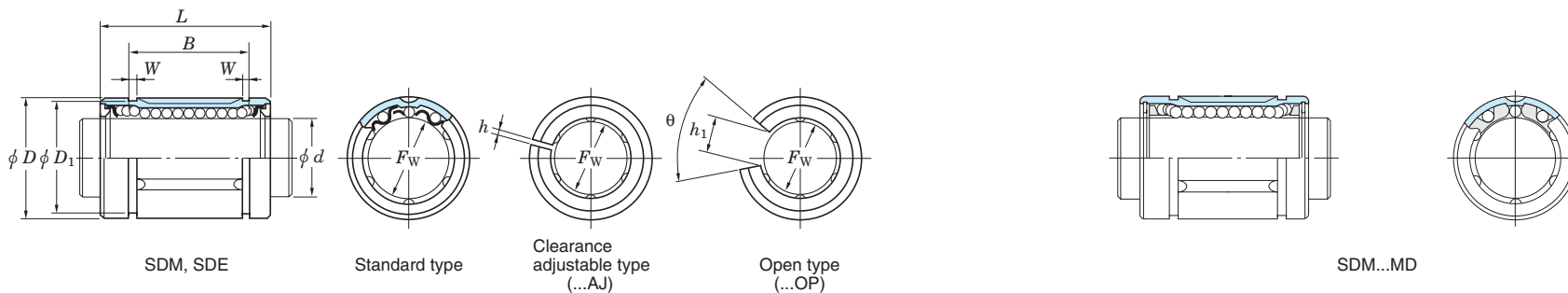

Shaft dia. (mm)	Dimensions (mm)									Bearing No. ¹⁾			No. of ball rows			Basic load ratings (N)		(Refer.) Mass (g)
	d	F _w	D	L	B	W	D ₁	h	h ₁	θ	Standard type	Clearance adjustable type	Open type	Standard type	Clearance adjustable type	Open type	C _r	C _{0r}
5	5	12	22	14.5	1.1	11.5	—	—	—	SDE5	—	—	3	—	—	108	183	10
6	6	12	19	13.5	1.1	11.5	1	—	—	SDM6	SDM6AJ	—	3	3	—	108	186	7
	6	12	19	13.5	1.1	11.5	1	—	—	SDM6MG	SDM6AJMG	—	4	4	—	108	186	6
8	8	15	17	11.5	1.1	14.3	1	—	—	SDM8S	SDM8SAJ	—	3	3	—	96	160	10
	8	15	17	11.5	1.1	14.3	1	—	—	SDM8SMG	SDM8SAJMG	—	4	4	—	96	160	9
	8	15	24	17.5	1.1	14.3	1	—	—	SDM8	SDM8AJ	—	3	3	—	122	223	14
	8	15	24	17.5	1.1	14.3	1	—	—	SDM8MG	SDM8AJMG	—	4	4	—	134	255	13
	8	16	25	16.5	1.1	15.2	1	—	—	SDE8	SDE8AJ	—	3	3	—	122	223	20
	8	16	25	16.5	1.1	15.2	1	—	—	SDE8MG	SDE8AJMG	—	4	4	—	134	255	18
10	10	19	29	22	1.3	18	1	6.8	80°	SDM10	SDM10AJ	SDM10OP	4	4	3	259	424	27
	10	19	29	22	1.3	18	1	—	—	SDM10MG	SDM8AJMG	—	4	4	—	259	424	23
	10	19	29	22	1.3	18	1	6.8	80°	SDE10	SDE10AJ	SDE10OP	4	4	3	259	424	27
	10	19	29	22	1.3	18	1	—	—	SDE10MG	SDE10AJMG	—	4	4	—	259	424	23
12	12	21	30	23	1.3	20	1.5	8	80°	SDM12	SDM12AJ	SDM12OP	4	4	3	260	431	31
	12	21	30	23	1.3	20	1.5	—	—	SDM12MG	SDM12AJMG	—	4	4	—	260	431	27
	12	22	32	22.9	1.3	21	1.5	7.5	78°	SDE12	SDE12AJ	SDE12OP	4	4	3	289	503	42
	12	22	32	22.9	1.3	21	1.5	—	—	SDE12MG	SDM12AJMG	—	4	4	—	289	503	37
13	13	23	32	23	1.3	22	1.5	9	80°	SDM13	SDM13AJ	SDM13OP	4	4	3	289	506	41
	13	23	32	23	1.3	22	1.5	—	—	SDM13MG	SDM13AJMG	—	4	4	—	289	506	35
16	16	26	36	24.9	1.3	24.9	1.5	10	78°	SDE16	SDE16AJ	SDE16OP	4	4	3	319	587	53
	16	26	36	24.9	1.3	24.9	1.5	—	—	SDE16MG	SDE16AJMG	—	4	4	—	319	587	47
	16	28	37	26.5	1.6	27	1.5	11	80°	SDM16	SDM16AJ	SDM16OP	4	4	3	480	766	69
	16	28	37	26.5	1.6	27	1.5	—	—	SDM16MG	SDM16AJMG	—	4	4	—	480	766	59
20	20	32	42	30.5	1.6	30.5	1.5	11	60°	SDM20	SDM20AJ	SDM20OP	5	5	4	590	1 010	92
	20	32	42	30.5	1.6	30.5	1.5	—	—	SDM20MG	SDM20AJMG	—	5	5	—	590	1 010	79

[Note] 1) JTEKT also manufactures sealed types, which are identified by U (one side sealed) or UU (both sides sealed) after ball complement bore diameter number.

Linear ball bearings

d (20) ~ 80 mm

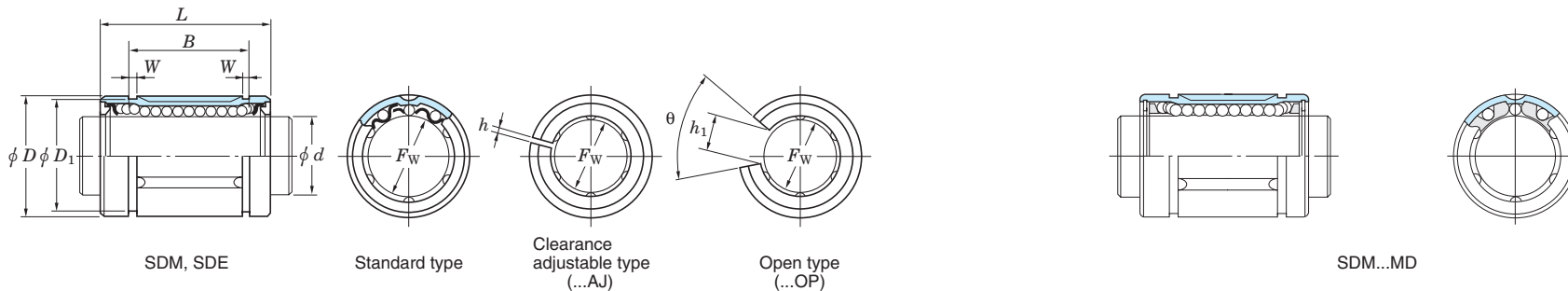

Shaft dia. (mm)	Dimensions (mm)									Bearing No. ¹⁾			No. of ball rows			Basic load ratings (N)		(Refer.) Mass (g)
	d	F _w	D	L	B	W	D ₁	h	h ₁	θ	Standard type	Clearance adjustable type	Open type	Standard type	Clearance adjustable type	Open type	C _r	C _{0r}
20	20	32	45	31.5	1.6	30.3	2	10	60°	SDE20	SDE20AJ	SDE200P	5	5	4	590	1 010	96
	20	32	45	31.5	1.6	30.3	2	—	—	SDE20MG	SDE20AJMG	—	5	5	—	590	1 010	88
25	25	40	58	44.1	1.85	37.5	2	12.5	60°	SDE25	SDE25AJ	SDE250P	5	5	4	1 130	2 030	190
	25	40	58	44.1	1.85	37.5	2	—	—	SDE25MG	SDE25AJMG	—	5	5	—	1 130	2 030	170
	25	40	59	41	1.85	38	2	12	60°	SDM25	SDM25AJ	SDM250P	5	5	4	1 130	2 030	200
	25	40	59	41	1.85	38	2	—	—	SDM25MG	SDM25AJMG	—	5	5	—	1 130	2 030	170
30	30	45	64	44.5	1.85	43	2.5	15	50°	SDM30	SDM30AJ	SDM300P	6	6	5	1 470	2 770	250
	30	45	64	44.5	1.85	43	2.5	—	—	SDM30MG	SDM30AJMG	—	6	6	—	1 470	2 770	220
	30	47	68	52.1	1.85	44.5	2	12.5	50°	SDE30	SDE30AJ	SDE300P	6	6	5	1 470	2 770	340
	30	47	68	52.1	1.85	44.5	2	—	—	SDE30MG	SDE30AJMG	—	6	6	—	1 470	2 770	320
35	35	52	70	49.5	2.1	49	2.5	17	50°	SDM35	SDM35AJ	SDM350P	6	6	5	1 580	3 070	370
	35	52	70	49.5	2.1	49	2.5	—	—	SDM35MG	SDM35AJMG	—	6	6	—	1 580	3 070	330
38	38	57	76	58.5	2.1	54.5	3	18	50°	SDM38	SDM38AJ	SDM380P	6	6	5	2 020	3 600	490
40	40	60	80	60.5	2.1	57	3	20	50°	SDM40	SDM40AJ	SDM400P	6	6	5	2 180	4 010	590
	40	60	80	60.5	2.1	57	3	—	—	SDM40MG	SDM40AJMG	—	6	6	—	2 180	4 010	530
	40	62	80	60.6	2.15	59	3	16.8	50°	SDE40	SDE40AJ	SDE400P	6	6	5	2 180	4 010	710
	40	62	80	60.6	2.15	59	3	—	—	SDE40MG	SDE40AJMG	—	6	6	—	2 180	4 010	650
50	50	75	100	77.6	2.65	72	3	21	50°	SDE50	SDE50AJ	SDE500P	6	6	5	4 020	7 110	1 050
	50	80	100	74	2.6	76.5	3	25	50°	SDM50	SDM50AJ	SDM500P	6	6	5	4 420	7 150	1 500
60	60	90	110	85	3.15	86.5	3	30	50°	SDM60	SDM60AJ	SDM600P	6	6	5	5 170	9 030	1 850
	60	90	125	101.7	3.15	86.5	3	27.2	54°	SDE60	SDE60AJ	SDE600P	6	6	5	6 470	11 100	1 900
80	80	120	140	105.5	4.15	116	3	40	50°	SDM80	SDM80AJ	SDM800P	6	6	5	8 180	12 800	4 200
	80	120	165	133.7	4.15	116	3	36.3	54°	SDE80	SDE80AJ	SDE800P	6	6	5	8 890	14 500	4 800

[Note] 1) JTEKT also manufactures sealed types, which are identified by U (one side sealed) or UU (both sides sealed) after ball complement bore diameter number.

d 100 ~ 120 mm

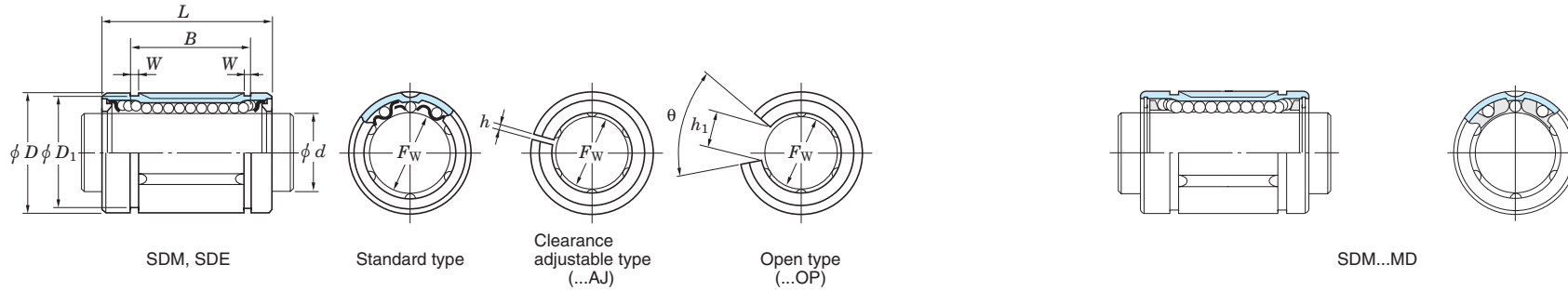

Shaft dia. (mm)	Dimensions (mm)									Bearing No. ¹⁾			No. of ball rows			Basic load ratings (N)		(Refer.) Mass (g)
	d	F_w	D	L	B	W	D_1	h	h_1	θ	Standard type	Clearance adjustable type	Open type	Standard type	Clearance adjustable type	Open type	C_r	C_{0r}
100	100	150	175	125.5	4.15	145	3	50	50°	SDM100	SDM100AJ	SDM100OP	6	6	5	12 300	19 700	8 200
120	120	180	200	158.6	4.15	175	4	85	80°	SDM120	SDM120AJ	SDM120OP	8	8	6	22 300	39 100	15 500

[Note] 1) JTEKT also manufactures sealed types, which are identified by U (one side sealed) or UU (both sides sealed) after ball complement bore diameter number.

Linear ball bearings
flanged type

d 6 ~ 50 mm

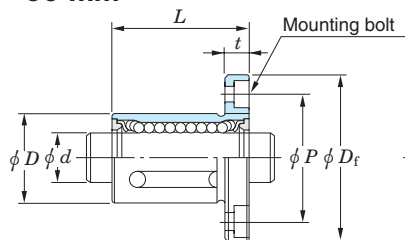

SDMF, SDMK

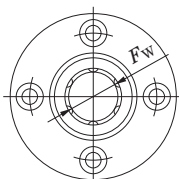

Round-flanged

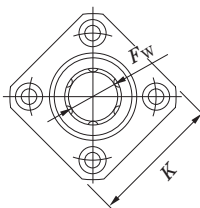

Square-flanged

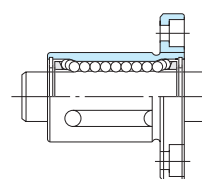

SDMF...MG
SDMK...MG (Synthetic resin)

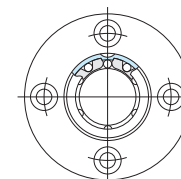

Round-flanged

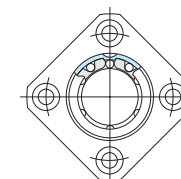

Square-flanged

Shaft dia. (mm) d	Dimensions (mm)							Bolt size	Bearing No.		No. of ball rows	Basic load ratings (N)		(Refer.) Mass (g) Round-flanged type
	F_w	D	L	D_f	K	t	P		Round-flanged type	Square-flanged type		C_r	C_{0r}	
6	6	12	19	28	22	5	20	M3	SDMF6	SDMK6	3	108	186	23
	6	12	19	28	22	5	20	M3	SDMF6MG	SDMK6MG		4	108	186
8	8	15	24	32	25	5	24	M3	SDMF8	SDMK8	3	122	223	35
	8	15	24	32	25	5	24	M3	SDMF8MG	SDMK8MG		4	134	255
10	10	19	29	40	30	6	29	M4	SDMF10	SDMK10	4	259	424	65
	10	19	29	40	30	6	29	M4	SDMF10MG	SDMK10MG		4	259	424
12	12	21	30	42	32	6	32	M4	SDMF12	SDMK12	4	260	431	72
	12	21	30	42	32	6	32	M4	SDMF12MG	SDMK12MG		4	260	431
13	13	23	32	43	34	6	33	M4	SDMF13	SDMK13	4	289	506	83
	13	23	32	43	34	6	33	M4	SDMF13MG	SDMK13MG		4	289	506
16	16	28	37	48	37	6	38	M4	SDMF16	SDMK16	4	480	766	120
	16	28	37	48	37	6	38	M4	SDMF16MG	SDMK16MG		4	480	766
20	20	32	42	54	42	8	43	M5	SDMF20	SDMK20	5	590	1 010	170
	20	32	42	54	42	8	43	M5	SDMF20MG	SDMK20MG		5	590	1 010
25	25	40	59	62	50	8	51	M5	SDMF25	SDMK25	5	1 130	2 030	290
	25	40	59	62	50	8	51	M5	SDMF25MG	SDMK25MG		5	1 130	2 030
30	30	45	64	74	58	10	60	M6	SDMF30	SDMK30	6	1 470	2 770	440
	30	45	64	74	58	10	60	M6	SDMF30MG	SDMK30MG		6	1 470	2 770
35	35	52	70	82	64	10	67	M6	SDMF35	SDMK35	6	1 580	3 070	610
	35	52	70	82	64	10	67	M6	SDMF35MG	SDMK35MG		6	1 580	3 070
40	40	60	80	96	75	13	78	M8	SDMF40	SDMK40	6	2 180	4 010	1 000
	40	60	80	96	75	13	78	M8	SDMF40MG	SDMK40MG		6	2 180	4 010
50	50	80	100	116	92	13	98	M8	SDMF50	SDMK50	6	4 420	7 150	2 000

**Linear ball bearings
flanged type**

d 60 ~ 80 mm

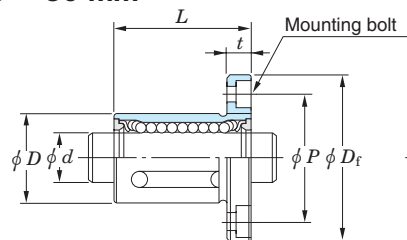

SDMF, SDMK

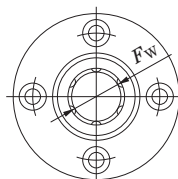

Round-flanged

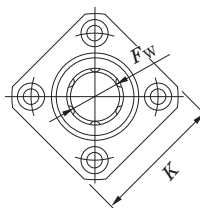

Square-flanged

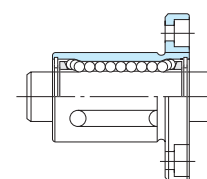

SDMF...MG
SDMK...MG (Synthetic resin)

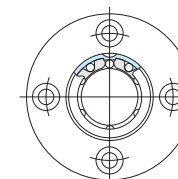

Round-flanged

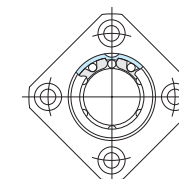

Square-flanged

Shaft dia. (mm)	Dimensions (mm)							Bolt size	Bearing No.		No. of ball rows	Basic load ratings (N)		(Refer.) Mass (g) Round-flanged type
	<i>F_w</i>	<i>D</i>	<i>L</i>	<i>D_f</i>	<i>K</i>	<i>t</i>	<i>P</i>		Round-flanged type	Square-flanged type		<i>C_r</i>	<i>C_{0r}</i>	
60	60	90	110	134	106	18	112	M10	SDMF60	SDMK60	6	5 170	9 030	2 800
80	80	120	140	164	136	18	142	M10	SDMF80	SDMK80	6	8 180	12 800	5 400

Locknuts, lockwashers & lock plates

Bearings are often fit to a shaft with an adapter sleeve, locknut, lockwasher or lock plate.

These accessories make it easy to attach and remove bearings.

They are standardized in JIS.

- Locknuts are standardized such that they can be used with either adapter sleeves, withdrawal sleeves or shafts.
- Lockwashers and lock plates are used as locks on locknuts.

Lockwashers are used with bearings of bore diameter number 40 or lower. Lock plates are used with those of bore diameter 44 or higher.

Locknuts

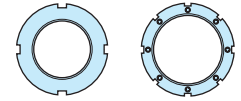

AN (ANL) 02 - 100

HN (HNL) 41 - 110

Lockwashers and lock plates

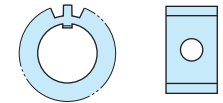

AW (AWL) 00 - 40(X)

AL (ALL) 44 - 100



Locknuts
for adapter sleeves and shafts

AN02 ~ 25

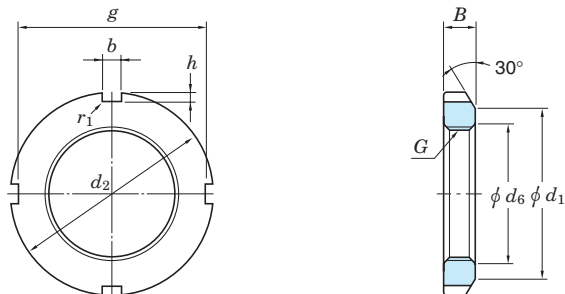

Locknut No.	Thread size ¹⁾ G	Standard dimensions (mm)								(Refer.) Mass (kg)	Applicable ²⁾ adapter sleeve (bore No.)	Applicable ³⁾ lockwasher No.
		d ₂	d ₁	g	d ₆	b	h	B	r ₁ max.			
AN 02	M 15×1	25	21	21	15.5	4	2	5	0.4	0.010	—	AW 02
03	M 17×1	28	24	24	17.5	4	2	5	0.4	0.013	—	03
04	M 20×1	32	26	28	20.5	4	2	6	0.4	0.019	04	04
AN 05	M 25×1.5	38	32	34	25.8	5	2	7	0.4	0.025	05	AW 05
06	M 30×1.5	45	38	41	30.8	5	2	7	0.4	0.043	06	06
07	M 35×1.5	52	44	48	35.8	5	2	8	0.4	0.053	07	07
AN 08	M 40×1.5	58	50	53	40.8	6	2.5	9	0.5	0.085	08	AW 08
09	M 45×1.5	65	56	60	45.8	6	2.5	10	0.5	0.119	09	09
10	M 50×1.5	70	61	65	50.8	6	2.5	11	0.5	0.148	10	10
AN 11	M 55×2	75	67	69	56	7	3	11	0.5	0.158	11	AW 11
12	M 60×2	80	73	74	61	7	3	11	0.5	0.174	12	12
13	M 65×2	85	79	79	66	7	3	12	0.5	0.203	13	13
AN 14	M 70×2	92	85	85	71	8	3.5	12	0.5	0.242	14	AW 14
15	M 75×2	98	90	91	76	8	3.5	13	0.5	0.287	15	15
16	M 80×2	105	95	98	81	8	3.5	15	0.6	0.397	16	16
AN 17	M 85×2	110	102	103	86	8	3.5	16	0.6	0.451	17	AW 17
18	M 90×2	120	108	112	91	10	4	16	0.6	0.556	18	18
19	M 95×2	125	113	117	96	10	4	17	0.6	0.658	19	19
AN 20	M100×2	130	120	122	101	10	4	18	0.6	0.698	20	AW 20
21	M105×2	140	126	130	106	12	5	18	0.7	0.845	21	21
22	M110×2	145	133	135	111	12	5	19	0.7	0.965	22	22
AN 23	M115×2	150	137	140	116	12	5	19	0.7	1.01	—	AW 23
24	M120×2	155	138	145	121	12	5	20	0.7	1.08	24	24
25	M125×2	160	148	150	126	12	5	21	0.7	1.19	—	25

[Notes] 1) Basic profile and dimension of screw thread are in accordance with JIS B 0205.
2) Applicable to adapter sleeve series A31, A2, A3 and A23.
3) Applicable to lockwashers with flat inner tongue.

[Remark] Locknut series AN is used for adapter assembly series H2, H3, H23 and H31, while locknut series ANL is used for adapter assembly series H30.

AN 26 ~ 40
ANL24 ~ 40

Locknut No.	Thread size ¹⁾ G	Standard dimensions (mm)								(Refer.) Mass (kg)	Applicable ²⁾ adapter sleeve (bore No.)	Applicable ³⁾ lockwasher No.
		d ₂	d ₁	g	d ₆	b	h	B	r ₁ max.			
AN 26	M130×2	165	149	155	131	12	5	21	0.7	1.25	26	AW 26
AN 27	M135×2	175	160	163	136	14	6	22	0.7	1.55	—	AW 27
28	M140×2	180	160	168	141	14	6	22	0.7	1.56	28	28
AN 29	M145×2	190	172	178	146	14	6	24	0.7	1.80	—	AW 29
30	M150×2	195	171	183	151	14	6	24	0.7	2.03	30	30
31	M155×3	200	182	186	156.5	16	7	25	0.7	2.30	—	—
AN 32	M160×3	210	182	196	161.5	16	7	25	0.7	2.59	32	AW 32
33	M165×3	210	193	196	166.5	16	7	26	0.7	2.70	—	—
34	M170×3	220	193	206	171.5	16	7	26	0.7	2.80	34	34
AN 36	M180×3	230	203	214	181.5	18	8	27	0.7	3.07	36	AW 36
38	M190×3	240	214	224	191.5	18	8	28	0.7	3.39	38	38
40	M200×3	250	226	234	201.5	18	8	29	0.7	3.69	40	40
ANL24	M120×2	145	133	135	121	12	5	20	0.7	0.78	24	AWL24
26	M130×2	155	143	145	131	12	5	21	0.7	0.88	26	26
28	M140×2	165	151	153	141	14	6	22	0.7	0.99	28	28
ANL30	M150×2	180	164	168	151	14	6	24	0.7	1.33	30	AWL30
32	M160×3	190	174	176	161.5	16	7	25	0.7	1.56	32	32
34	M170×3	200	184	186	171.5	16	7	26	0.7	1.72	34	34
ANL36	M180×3	210	192	194	181.5	18	8	27	0.7	1.95	36	AWL36
38	M190×3	220	202	204	191.5	18	8	28	0.7	2.08	38	38
40	M200×3	240	218	224	201.5	18	8	29	0.7	2.98	40	40

Locknuts
for adapter sleeves and shafts

ANL 80 ~ 100

AN 44 ~ 100

ANL 44 ~ 76

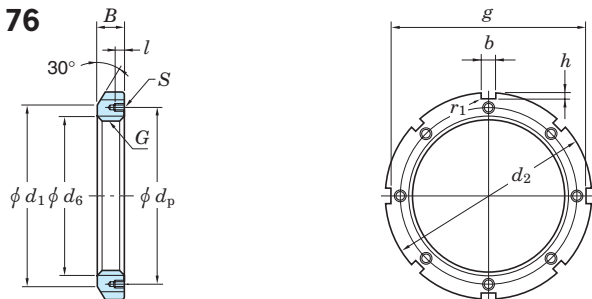

Locknut No.	Thread ¹⁾ size	Standard dimensions (mm)								Tapped hole ²⁾ (mm)			(Refer.) Mass (kg)	Applicable adapter sleeve ³⁾ (bore No.)	Applicable lock plate No.
		d ₂	d ₁	g	d ₆	b	h	B	r _{1 max.}	l	S Thread size	d _p			
AN 44	Tr220×4	280	250	260	222	20	10	32	0.8	15	M 8×1.25	238	5.16	44	AL 44
48	Tr240×4	300	270	280	242	20	10	34	0.8	15	M 8×1.25	258	5.91	48	44
52	Tr260×4	330	300	306	262	24	12	36	0.8	18	M10×1.5	281	7.99	52	52
AN 56	Tr280×4	350	320	326	282	24	12	38	0.8	18	M10×1.5	301	8.99	56	AL 52
60	Tr300×4	380	340	356	302	24	12	40	0.8	18	M10×1.5	326	11.7	60	60
64	Tr320×5	400	360	376	322.5	24	12	42	0.8	18	M10×1.5	345	13.0	64	64
AN 68	Tr340×5	440	400	410	342.5	28	15	55	1	21	M12×1.75	372	23.0	68	AL 68
72	Tr360×5	460	420	430	362.5	28	15	58	1	21	M12×1.75	392	25.0	72	68
76	Tr380×5	490	450	454	382.5	32	18	60	1	21	M12×1.75	414	30.8	76	76
AN 80	Tr400×5	520	470	484	402.5	32	18	62	1	27	M16×2	439	36.7	80	AL 80
84	Tr420×5	540	490	504	422.5	32	18	70	1	27	M16×2	459	43.3	84	80
88	Tr440×5	560	510	520	442.5	36	20	70	1	27	M16×2	477	45.1	88	88
AN 92	Tr460×5	580	540	540	462.5	36	20	75	1	27	M16×2	497	50.2	92	AL 88
96	Tr480×5	620	560	580	482.5	36	20	75	1	27	M16×2	527	62.0	96	96
100	Tr500×5	630	580	584	502.5	40	23	80	1	27	M16×2	539	63.1	/500	100

Locknut No.	Thread ¹⁾ size	Standard dimensions (mm)								Tapped hole ²⁾ (mm)			(Refer.) Mass (kg)	Applicable adapter sleeve ³⁾ (bore No.)	Applicable lock plate No.
		d ₂	d ₁	g	d ₆	b	h	B	r _{1 max.}	l	S Thread size	d _p			
ANL80	Tr400×5	470	442	442	402.5	28	14	52	1	18	M10×1.5	418	16.9	80	ALL76
84	Tr420×5	490	462	462	422.5	32	14	52	1	18	M10×1.5	438	17.4	84	84
88	Tr440×5	520	490	490	442.5	32	15	60	1	21	M12×1.75	462	26.2	88	88
ANL92	Tr460×5	540	510	510	462.5	32	15	60	1	21	M12×1.75	482	26.9	92	ALL88
96	Tr480×5	560	530	530	482.5	36	15	60	1	21	M12×1.75	502	28.3	96	96
100	Tr500×5	580	550	550	502.5	36	15	68	1	21	M12×1.75	522	33.6	/500	96

ANL44	Tr220×4	260	242	242	222	20	9	30	0.8	12	M 6×1	229	3.09	44	ALL44
48	Tr240×4	290	270	270	242	20	10	34	0.8	15	M 8×1.25	253	5.16	48	48
52	Tr260×4	310	290	290	262	20	10	34	0.8	15	M 8×1.25	273	5.67	52	48
ANL56	Tr280×4	330	310	310	282	24	10	38	0.8	15	M 8×1.25	293	6.78	56	ALL56
60	Tr300×4	360	336	336	302	24	12	42	0.8	15	M 8×1.25	316	9.62	60	60
64	Tr320×5	380	356	356	322.5	24	12	42	0.8	15	M 8×1.25	335	9.94	64	64
ANL68	Tr340×5	400	376	376	342.5	24	12	45	1	15	M 8×1.25	355	11.7	68	ALL64
72	Tr360×5	420	394	394	362.5	28	13	45	1	15	M 8×1.25	374	12.0	72	72
76	Tr380×5	450	422	422	382.5	28	14	48	1	18	M10×1.5	398	14.9	76	76

[Notes] 1) Basic profile and dimension of screw thread are in accordance with JIS B 0216.
2) Basic profile and dimension of bore with internal thread are in accordance with JIS B 0205.
3) Applicable to adapter sleeve series A31, A32, A23 and A30.

Locknuts
for withdrawal sleeves

HN 42 ~ 110

HNL 41 ~ 64

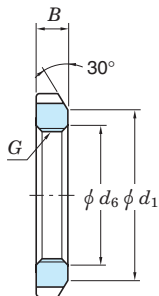
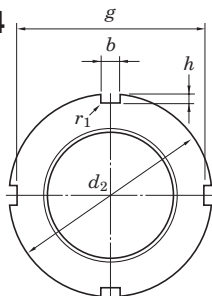

HNL 69 ~ 108

Locknut No.	Thread ¹⁾ size	Standard dimensions (mm)								(Refer.) Mass (kg)	Withdrawal sleeve No.			
		<i>G</i>	<i>d</i> ₂	<i>d</i> ₁	<i>g</i>	<i>d</i> ₆	<i>b</i>	<i>h</i>	<i>B</i>		<i>r</i> _{1 max.}			
HN 42	Tr210×4	270	238	250	212	20	10	30	0.8	4.75	AH3138	AH2238	AH3238	AH2338
	Tr220×4	280	250	260	222	20	10	32	0.8	5.35	3140	2240	3240	2340
	Tr240×4	300	270	280	242	20	10	34	0.8	6.20	3144	2244	—	2344
HN 52	Tr260×4	330	300	306	262	24	12	36	0.8	8.55	AH3148	AH2248	—	AH2348
	Tr290×4	370	330	346	292	24	12	40	0.8	11.8	3152	2252	—	2352
	Tr310×5	390	350	366	312.5	24	12	42	0.8	13.4	3156	2256	—	2356
HN 66	Tr330×5	420	380	390	332.5	28	15	52	1	20.4	AH3160	AH2260	AH3260	—
	Tr350×5	450	410	420	352.5	28	15	55	1	25.2	3164	2264	3264	—
	Tr370×5	470	430	440	372.5	28	15	58	1	28.2	3168	—	3268	—
HN 80	Tr400×5	520	470	484	402.5	32	18	62	1	40.0	AH3172	—	AH3272	—
	Tr420×5	540	490	504	422.5	32	18	70	1	46.9	3176	—	3276	—
	Tr440×5	560	510	520	442.5	36	20	70	1	48.5	3180	—	3280	—
HN 92	Tr460×5	580	540	540	462.5	36	20	75	1	55.0	AH3184	—	AH3284	—
	Tr480×5	620	560	580	482.5	36	20	75	1	67.0	X3188	—	X3288	—
	Tr510×6	650	590	604	513	40	23	80	1	75.0	X3192	—	X3292	—
HN 106	Tr530×6	670	610	624	533	40	23	80	1	78.0	AHX3196	—	AHX3296	—
	Tr550×6	700	640	654	553	40	23	80	1	92.5	X31/500	—	X32/500	—
HNL 41	Tr205×4	250	232	234	207	18	8	30	0.8	3.43	AH3038	AH238	—	—
	Tr215×4	260	242	242	217	20	9	30	0.8	3.72	3040	240	—	—
	Tr235×4	280	262	262	237	20	9	34	0.8	4.60	3044	244	—	—
HNL 52	Tr260×4	310	290	290	262	20	10	34	0.8	5.80	AH3048	AH248	—	—
	Tr280×4	330	310	310	282	24	10	38	0.8	6.72	3052	252	—	—
	Tr300×4	360	336	336	302	24	12	42	0.8	9.60	3056	256	—	—
HNL 64	Tr320×5	380	356	356	322.5	24	12	42	1	10.3	AH3060	—	—	—

Locknut No.	Thread ¹⁾ size	Standard dimensions (mm)								(Refer.) Mass (kg)	Withdrawal sleeve No.			
		<i>G</i>	<i>d</i> ₂	<i>d</i> ₁	<i>g</i>	<i>d</i> ₆	<i>b</i>	<i>h</i>	<i>B</i>		<i>r</i> _{1 max.}			
HNL 69	Tr345×5	410	384	384	347.5	28	13	45	1	11.5	3064	—	—	—
	Tr365×5	430	404	404	367.5	28	13	48	1	14.2	3068	—	—	—
HNL 77	Tr385×5	450	422	422	387.5	28	14	48	1	15.0	AH3072	—	—	—
	Tr410×5	480	452	452	412.5	32	14	52	1	19.0	3076	—	—	—
	Tr430×5	500	472	472	432.5	32	14	52	1	19.8	3080	—	—	—
HNL 90	Tr450×5	520	490	490	452.5	32	15	60	1	23.8	AH3084	—	—	—
	Tr470×5	540	510	510	472.5	32	15	60	1	25.0	X3088	—	—	—
	Tr490×5	580	550	550	492.5	36	15	60	1	34.0	X3092	—	—	—
HNL104	Tr520×6	600	570	570	523	36	15	68	1	37.0	AHX3096	—	—	—
	Tr540×6	630	590	590	543	40	20	68	1	43.5	X30/500	—	—	—

[Note] 1) Basic profile and dimension of screw thread are in accordance with JIS B 0216.
[Remark] Number of slots on nut may sometimes exceed that shown in the figure.

AW 00 ~ 24(X)

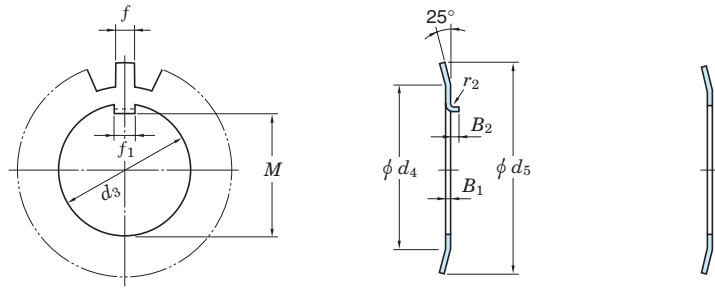

With bent inner tongue

With flat inner tongue

AW 25 ~ 40(X)

AWL24 ~ 40(X)

Lockwasher No.	Standard dimensions (mm)										No. of tooth	(Refer.) Mass (kg/100pcs.)	Applicable adapter sleeve (bore No.)	Applicable locknut No.
	With bent inner tongue	With flat inner tongue	d_3	M	f_1	B_1	f	d_4	d_5	r_2				
AW 00	AW 00X	10	8.5	3	1	3	13	21	0.5	2	9	0.131	—	AN 00
01	01X	12	10.5	3	1	3	17	25	0.5	2	9	0.192	—	01
02	02X	15	13.5	4	1	4	21	28	1	2.5	13	0.253	—	02
AW 03	AW 03X	17	15.5	4	1	4	24	32	1	2.5	13	0.313	—	AN 03
04	04X	20	18.5	4	1	4	26	36	1	2.5	13	0.350	04	04
05	05X	25	23	5	1.2	5	32	42	1	2.5	13	0.640	05	05
AW 06	AW 06X	30	27.5	5	1.2	5	38	49	1	2.5	13	0.780	06	AN 06
07	07X	35	32.5	6	1.2	5	44	57	1	2.5	15	1.04	07	07
08	08X	40	37.5	6	1.2	6	50	62	1	2.5	15	1.23	08	08
AW 09	AW 09X	45	42.5	6	1.2	6	56	69	1	2.5	17	1.52	09	AN 09
10	10X	50	47.5	6	1.2	6	61	74	1	2.5	17	1.60	10	10
11	11X	55	52.5	8	1.2	7	67	81	1	4	17	1.96	11	11
AW 12	AW 12X	60	57.5	8	1.5	7	73	86	1.2	4	17	2.53	12	AN 12
13	13X	65	62.5	8	1.5	7	79	92	1.2	4	19	2.90	13	13
14	14X	70	66.5	8	1.5	8	85	98	1.2	4	19	3.34	14	14
AW 15	AW 15X	75	71.5	8	1.5	8	90	104	1.2	4	19	3.56	15	AN 15
16	16X	80	76.5	10	1.8	8	95	112	1.2	4	19	4.64	16	16
17	17X	85	81.5	10	1.8	8	102	119	1.2	4	19	5.24	17	17
AW 18	AW 18X	90	86.5	10	1.8	10	108	126	1.2	4	19	6.23	18	AN 18
19	19X	95	91.5	10	1.8	10	113	133	1.2	4	19	6.70	19	19
20	20X	100	96.5	12	1.8	10	120	142	1.2	6	19	7.65	20	20
AW 21	AW 21X	105	100.5	12	1.8	12	126	145	1.2	6	19	8.26	21	AN 21
22	22X	110	105.5	12	1.8	12	133	154	1.2	6	19	9.40	22	22
23	23X	115	110.5	12	2	12	137	159	1.5	6	19	10.8	—	23
AW 24	AW 24X	120	115	14	2	12	138	164	1.5	6	19	10.5	24	AN 24

Lockwasher No.	Standard dimensions (mm)										No. of tooth	(Refer.) Mass (kg/100pcs.)	Applicable adapter sleeve (bore No.)	Applicable locknut No.
	With bent inner tongue	With flat inner tongue	d_3	M	f_1	B_1	f	d_4	d_5	r_2				
AW 25	AW 25X	125	120	14	2	12	148	170	1.5	6	19	11.8	—	25
26	26X	130	125	14	2	12	149	175	1.5	6	19	11.3	26	26
AW 27	AW 27X	135	130	14	2	14	160	185	1.5	6	19	14.4	—	AN 27
28	28X	140	135	16	2	14	160	192	1.5	8	19	14.2	28	28
29	29X	145	140	16	2	14	172	202	1.5	8	19	16.8	—	29
AW 30	AW 30X	150	145	16	2	14	171	205	1.5	8	19	15.5	30	AN 30
31	31X	155	147.5	16	2.5	16	182	212	1.5	8	19	20.9	—	31
32	32X	160	154	18	2.5	16	182	217	1.5	8	19	22.2	32	32
AW 33	AW 33X	165	157.5	18	2.5	16	193	222	1.5	8	19	24.1	—	AN 33
34	34X	170	164	18	2.5	16	193	232	1.5	8	19	24.7	34	34
36	36X	180	174	20	2.5	18	203	242	1.5	8	19	26.8	36	36
AW 38	AW 38X	190	184	20	2.5	18	214	252	1.5	8	19	27.8	38	AN 38
40	40X	200	194	20	2.5	18	226	262	1.5	8	19	29.3	40	40

AWL24	AWL24X	120	115	14	2	12	133	155	1.5	6	19	7.70	24	ANL24
26	26X	130	125	14	2	12	143	165	1.5	6	19	8.70	26	26
28	28X	140	135	16	2	14	151	175	1.5	8	19	10.9	28	28
AWL30	AWL30X	150	145	16	2	14	164	190	1.5	8	19	11.3	30	ANL30
32	32X	160	154	18	2.5	16	174	200	1.5	8	19	16.2	32	32
34	34X	170	164	18	2.5	16	184	210	1.5	8	19	19.0	34	34
AWL36	AWL36X	180	174	20	2.5	18	192	220	1.5	8	19	18.0	36	ANL36
38	38X	190	184	20	2.5	18	202	230	1.5	8	19	20.5	38	38
40	40X	200	194	20	2.5	18	218	250	1.5	8	19	21.4	40	40

(Remark) 1) AW00~AW40, AW00X~AW40X are applicable to adapter assembly series H31, H2, H3 and H23.
 2) AWL24~AWL40, AWL24X~AWL40X are applied to adapter assembly series H30.
 3) For adapter sleeves with narrow slits, lockwashers with flat inner tongue should be used. Either type of lockwasher can be used for adapter sleeves with wide slits.

Lock plates

AL 44 ~ 100

ALL44 ~ 96

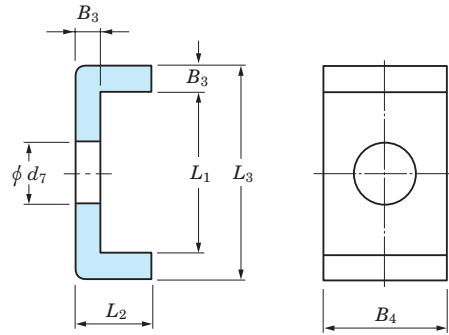

Lock plate No.	Standard dimensions (mm)						(Refer.) Mass (kg/100pcs.)	Applicable locknut No.
	B_3	B_4	L_2	d_7	L_1	L_3		
AL 44	4	20	12	9	22.5	30.5	2.60	AN 44,48
52	4	24	12	12	25.5	33.5	3.39	52,56
60	4	24	12	12	30.5	38.5	3.79	60
AL 64	5	24	15	12	31	41	5.35	AN 64
68	5	28	15	14	38	48	6.65	68,72
76	5	32	15	14	40	50	7.96	76
AL 80	5	32	15	18	45	55	8.20	AN 80,84
88	5	36	15	18	43	53	9.00	88,92
96	5	36	15	18	53	63	10.4	96
100	5	40	15	18	45	55	10.5	100
ALL44	4	20	12	7	13.5	21.5	2.12	ANL44
48	4	20	12	9	17.5	25.5	2.29	48,52
56	4	24	12	9	17.5	25.5	2.92	56
ALL60	4	24	12	9	20.5	28.5	3.16	ANL60
64	5	24	15	9	21	31	4.56	64,68
72	5	28	15	9	20	30	5.03	72
ALL76	5	28	15	12	24	34	5.28	ANL76,80
84	5	32	15	12	24	34	6.11	84
88	5	32	15	14	28	38	6.45	88,92
96	5	36	15	14	28	38	7.29	96,100

[Remark] Lock plate series AL are applicable to adapter assembly series H31, H32 and H23, while lock plate series ALL are applicable to H30.